



MASERATI

2014 QUATTROPORTE



JANUARY 2013



POSITIONING 3

HISTORY 4

MODEL RANGE 5

2014 QUATTROPORTE:

V6 AWD 6

V8 RWD 7

EXTERIOR HIGHLIGHTS 8

INTERIOR HIGHLIGHTS 9

ALL-WHEEL DRIVE 10

VEHICLE SPECIFICATIONS 11

DIMENSIONS 12

COMPETITOR DIMENSIONS 13

EXTERIOR PAINT 14

INTERIOR PAINT 15

INTERIOR TRIM 16

WHEELS & BRAKE CALIPERS 17

STANDARD EQUIPMENT 18

OPTIONAL EQUIPMENT 20

PACKAGING 22

ENGINE SPECIFICATIONS 23

The 2014 Quattroporte is the Maserati flagship and is the sixth generation of the original luxury sport sedan created in 1963. With the first Quattroporte, a racing engine was combined with a superb performance sedan to deliver world-class performance. The new Quattroporte remains faithful to this tradition by combining superior style, space, comfort and speed.

The new Quattroporte is larger, lighter, more luxurious and practical than the acclaimed car it replaces. With a 191 mph (307 km/h) top speed, it is the fastest and most powerful four-door Maserati ever built. Its 523 HP V-8 engine and the large cabin are central to the Quattroporte's design, dominated by a long, powerful hood with flowing lines and concave Trident grill which provide a clear link to Maserati's purely Italian tradition of GranTurismo.

Maserati Quattroporte boasts new-technology intercooled and direct-injected twin turbo engines. A 3.8-Liter V8 and a 3.0-Liter V6 were each designed by Maserati and are hand-assembled by Ferrari in Maranello, Italy. Engineered at the highest development level, the new turbocharged powerplants set benchmarks for Maserati horsepower and efficiency while producing the unique Maserati sound.

The spacious interior is an environment of exquisite simplicity where driving and design are in harmony and technology is readily at hand and easily used. The quality and selection of fine materials and colors creates a design that stimulates feelings of happiness. For the first time in the new Quattroporte, the security of standard All-Wheel Drive is available on the turbo V-6 variant, providing improved traction under a variety of road conditions and impressive acceleration.

The new Quattroporte is the Italian vision of how perfectly beautiful a luxury sport sedan can be while setting the tone for Maserati's future and remaining faithful to the history of Maserati.

PERFORMANCE – 523 HP V-8 with 0-60 mph in 4.6 seconds and a 191 mph top speed

DESIGN – The classic Maserati style from the flowing vehicle lines to the concave grill with Trident

SPACE – The longest and most spacious Maserati ever offered with true comfort for five

EFFICIENCY – Twin-turbo engines, 220 lb lighter weight and 20% improved economy and emissions

TWIN-TURBO V-6 WITH AWD – The most secure all-weather performance car in Maserati history



MASERATI HERITAGE

In 1963 Maserati originated the concept of a sports sedan with the launch of Quattroporte. Since that time, the Quattroporte has been admired for its balance of style, luxury and high performance.

1963



MASERATI QUATTROPORTE I

1979



MASERATI QUATTROPORTE III

2014



MASERATI QUATTROPORTE VI

1960 | 1965 | 1970 | 1975 | 1980 | 1985 | 1990 | 1995 | 2000 | 2005 | 2010 | 2015

MASERATI QUATTROPORTE II



1974

MASERATI QUATTROPORTE IV



1994

MASERATI QUATTROPORTE V



2004

2014 QUATTROPORTE MODEL RANGE



ALL-NEW 6TH GENERATION QUATTROPORTE



MODEL YEAR 2014 HIGHLIGHTS

- | | |
|---|---|
| • Keyless entry/starting system | • New ZF 8-Speed Transmission |
| • Rear parking camera, front & rear parking sensors | • New Maserati 8.4" touchscreen display |
| • New Maserati Twin Turbo Engines | • AWD for all weather performance |
| - 404 hp V6 | • +6.4 inches longer |
| - 523 hp V8 | • +2.5 inches wider |
| • 30% additional trunk space for luggage | • +4.1 inches longer wheelbase |



SPECIFICATIONS

| | |
|---------------------|-----------------------------------|
| ENGINE | 3.0 L Twin Turbo V6 |
| HORSEPOWER | 404 HP |
| TRANSMISSION | ZF 8-Speed Automatic Transmission |
| WHEELS | 19-inch Wheels |

STANDARD EQUIPMENT HIGHLIGHTS

- Power Sunroof
- Adaptive Bi-Xenon Headlights
- Rear View Camera
- 8.4-inch Touch Screen Navigation
- Keyless Entry-Go
- Sport Skyhook Suspension
- Heated Front Seats
- Front & Rear Parking Sensors
- Adjustable Foot Pedals
- Power Rear Side Sun Blinds

2014 QUATTROPORTE V8 RWD



SPECIFICATIONS

| | |
|--------------|-----------------------------------|
| ENGINE | 3.8 L Twin Turbo V8 |
| HORSEPOWER | 523 HP |
| TRANSMISSION | ZF 8-Speed Automatic Transmission |
| WHEELS | 20-inch Wheels |



STANDARD EQUIPMENT HIGHLIGHTS

Includes Quattroporte V6 Standard Equipment plus:

- Active Shift Paddles
- High gloss wood trim
- Heated Rear Seats
- Power Rear Sunblind
- Performance Brake Calipers
- 20-inch Wheels
- Premium Sound System: 600 Watts





MASERATI

2014 QUATTROPORTE EXTERIOR HIGHLIGHTS



2014 QUATTROPORTE INTERIOR HIGHLIGHTS

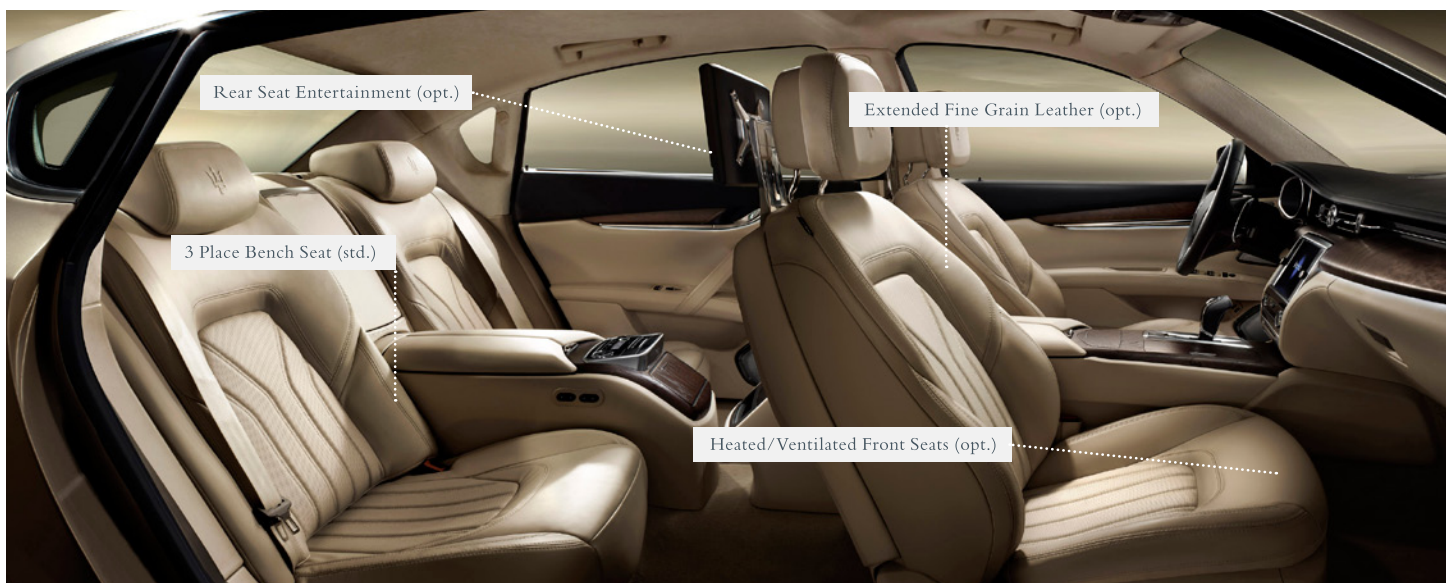



MASERATI

2014 QUATTROPORTE ALL WHEEL DRIVE

ALL-WHEEL DRIVE SECURITY

A completely new Maserati AWD system has been engineered for handling, efficiency and light weight. The all-wheel drive system is capable of distributing torque from rear to front and rear within 150 milliseconds, helping maximize traction and surefootedness in all weather conditions.



All-Wheel Drive Available
on Quattroporte V6 Only

INTELLIGENT Q4 AWD SYSTEM

The intelligent Q4 AWD system provides a performance-optimized torque split from 100% at the rear for high-speed, to a 50% split to the front axle for traction. Quattroporte AWD maximizes traction safety and works with the Maserati Stability Program to provide grip on the most slippery surfaces.



MASERATI TWIN-TURBO V6 ENGINE

The new Maserati V-6 twin-turbo engine powering the AWD system delivers 406 ft-lb of torque at only 1,750 rpm exceeding the last generation top version Quattroporte Sport GT S V-8 in a car weighing 200 lbs less with 60 mph reached in only 4.8 sec.

2014 QUATTROPORTE VEHICLE SPECIFICATIONS



MASERATI

| | QUATTROPORTE V6 | QUATTROPORTE V8 | |
|--------------------------------|-------------------------------------|----------------------|------------------------------------|
| ENGINE | Number of cylinders and layout | V6 | V8 90° |
| | Displacement (cu in) | 183 (3.0 L) | 232 (3.8 L) |
| | Bore x Stroke | 3.4" x 3.2" | 3.4" x 3.2" |
| | Compression Ratio | 9.5:1 | 9.5:1 |
| | Maximum power output | 404HP (410 CV) | 523HP (530 CV) |
| | Engine speed a maximum power output | 5500 rpm | 6500 / 6800 rpm |
| | Peak torque | 406 lb-ft | 479 lb-ft (524 lb-ft in overboost) |
| | RPM at peak torque | 1750 / 5000 rpm | 2000 / 4000 rpm |
| | Maximum RPM | 6500 rpm | 7200 rpm |
| | Transmission | ZF 8-Speed Automatic | ZF 8-Speed Automatic |
| DIMENSIONS & WEIGHT | Length | 207.2 in | 207.2 in |
| | Width (without mirrors) | 76.7 in | 76.7 in |
| | Width (with mirrors) | 82.7 in | 82.7 in |
| | Height | 58.3 in | 58.3 in |
| | Wheelbase | 124.8 in | 124.8 in |
| | Front Track | 64.3 in | 64.3 in |
| | Rear Track | 64.8 in | 64.8 in |
| | Front Overhang | 38.1 in | 38.1 in |
| | Rear Overhang | 44.2 in | 44.2 in |
| | Trunk Capacity | 18.7 cubic ft | 18.7 cubic ft |
| | Fuel Tank Capacity | 21.1 Gal | 21.1 Gal |
| | Turning Circle | 38.7 ft | 38.7 ft |
| WEIGHT | Curb Weight | 4226 lbs | 4191 lbs |
| PERFORMANCE | Top Speed | 176 mph | 191 mph |
| | Acceleration 0-60 km/h | 4.8 s | 4.6 s |

**Vehicles specs are preliminary and subject to change without notice.*

NEW 2014 QUATTROPORTE VI

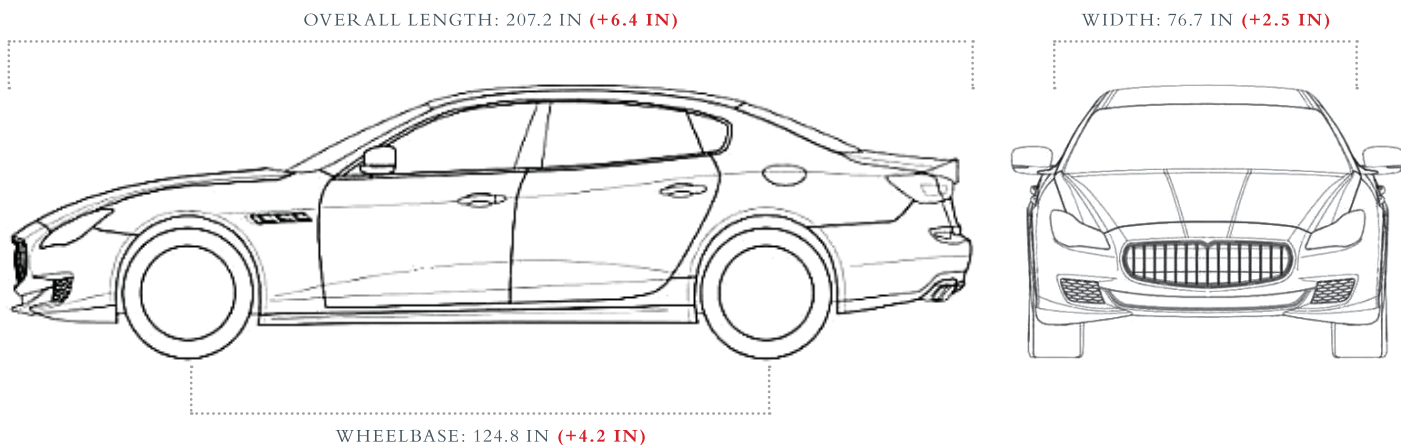

PREVIOUS 2004-2013 QUATTROPORTE V

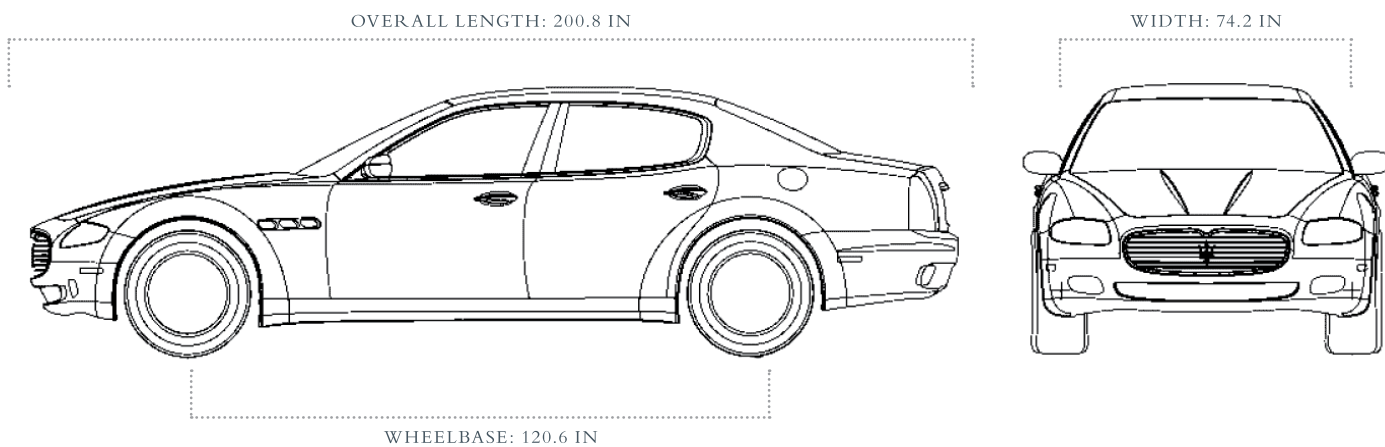

| | 2004-13 QUATTROPORTE | 2014 QUATTROPORTE | | |
|---------------|----------------------|-------------------|----------|----------------|
| INCHES | Length | 200.8 in | 207.2 in | +6.4 in |
| | Width | 74.2 in | 76.7 in | +2.5 in |
| | Wheelbase | 120.6 in | 124.8 in | +4.2 in |
| | Legroom | 34.4 in | 38.6 in | +4.1 in |

2014 QUATTROPORTE COMPETITOR DIMENSIONS



MASERATI

| | | 2014 QUATTROPORTE |
|--------|-----------|-------------------|
| INCHES | Length | 207.2 in |
| | Width | 76.7 in |
| | Wheelbase | 124.8 in |

| | | MERCEDES BENZ S550 | 2014 QUATTROPORTE * |
|--------|-----------|--------------------|---------------------|
| INCHES | Length | 206.5 in | +0.7 in |
| | Width | 73.7 in | +3.0 in |
| | Wheelbase | 124.6 in | +0.2 in |

| | | AUDI A8 LWB | 2014 QUATTROPORTE * |
|--------|-----------|-------------|---------------------|
| INCHES | Length | 207.4 in | -0.2 in |
| | Width | 76.7 in | 0.0 in |
| | Wheelbase | 122.9 in | +1.9 in |

| | | PORSCHE PANAMERA | 2014 QUATTROPORTE * |
|--------|-----------|------------------|---------------------|
| INCHES | Length | 195.7 in | +11.5 in |
| | Width | 76.0 in | +0.7 in |
| | Wheelbase | 115.0 in | +9.8 in |

| | | JAGUAR XJ L | 2014 QUATTROPORTE * |
|--------|-----------|-------------|---------------------|
| INCHES | Length | 206.6 in | +0.6 in |
| | Width | 74.6 in | +2.1 in |
| | Wheelbase | 124.4 in | +0.4 in |

SOLID PAINTS

Q820: BLACK



Q268: WHITE



MICA PAINTS

Q815: SILK BLACK



Q426: DEEP BLUE



METALLIC PAINTS

Q817: SILVER



METALLESCENT PAINTS

Q525: BRONZE



Q513: BEIGE



2014 QUATTROPORTE INTERIOR COLOR



LEATHER SEATS / LOWER DASHBOARD: STANDARD



BLACK



DARK BROWN



DOVE GREY



BEIGE



TAN

PREMIUM LEATHER: OPTIONAL

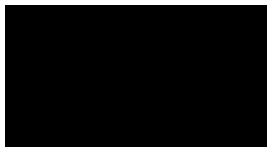

BLACK

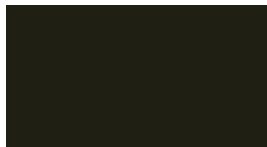

DARK BROWN



DOVE GREY



BEIGE



TAN

UPPER DASHBOARD

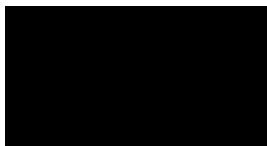

BLACK

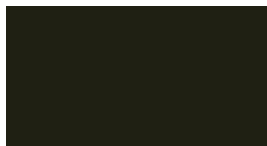

DARK BROWN

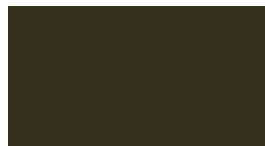

DOVE GREY



BLUE

CARPETS / SEAT BELTS

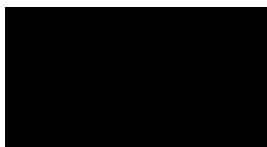

BLACK

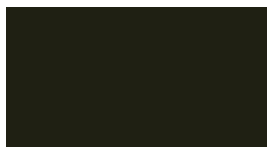

DARK BROWN



DOVE GREY



BEIGE

HEADLINER

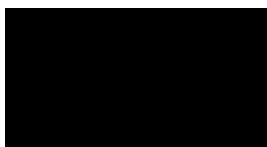

BLACK



GREY



DOVE GREY



BEIGE

STEERING WHEEL



BLACK



DARK BROWN



DOVE GREY









BEIGE

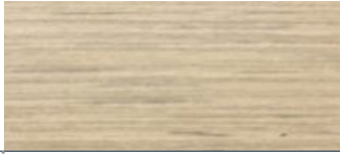

BLUE

TRIM

| | | | |
|--------------|---|--|---|
| |  |  |  |
| FINISH: | ERABLE | EBONY | TANGANIKA |
| DESCRIPTION: | A high-gloss, medium brown classic wood trim with a wave-type grain structure. | A high-gloss, brown wood trim with alternating bands of medium to dark brown. | A high-gloss, dark brown/grey wood trim with a fine dark grey linear structure. |
| |  |  |  |
| FINISH: | ASH BURL | PALE LIME | CARBON FIBER |
| DESCRIPTION: | A satin-finish, open pore medium brown wood trim with finely detailed indentations. | A satin-finish, open-pore light wood trim with wavy-grain structure and profile. | A semi-gloss technical, geometric, woven structure in dark grey. |

| | STEERING WHEEL INSERT (OPTIONAL) | | | | |
|-----------------------------|----------------------------------|-----------|-----------|----------|--------------|
| | ERABLE | PALE LIME | TANGANIKA | ASH BURL | CARBON FIBER |
| STEERING WHEEL COLOR | | | | | |
| BLACK | YES | ---- | ---- | YES | YES |
| DARK BROWN | YES | YES | ---- | ---- | ---- |
| DOVE GREY | YES | ---- | YES | ---- | ---- |
| BEIGE | YES | YES | ---- | ---- | ---- |
| BLUE | ---- | ---- | ---- | ---- | ---- |



NOTE:

Optional heated steering wheel is available for leather steering wheels with wood insert (not available for leather only or leather/Carbon Fiber steering wheels).

2014 QUATTROPORTE WHEELS & BRAKE CALIPERS



| | | | | | |
|---------------|------------|----------------|----------------|-------------|-------------|
| WHEELS | WHEEL TYPE | 19" Wheels | 20" Wheels | 20" Wheels | 21" Wheels |
| | FRONT TIRE | 245/45 R 19 | 245/40 R 20 | 245/40 R 20 | 245/35 R 21 |
| | REAR TIRE | 275/40 R 19 | 285/35 R 20 | 285/35 R 20 | 285/30 R 21 |
| | TIRE TYPE | ---- | ---- | ---- | ---- |
| | CODE | Q431 | Q439 | Q433 | Q421 |
| | MSRP | STANDARD on V6 | STANDARD on V8 | OPTIONAL | OPTIONAL |

BRAKE CALIPERS

Q4SU: BLACK STD



Q4TA: RED



Q4TB: BLUE



Q58I: SILVER



Q6AJ: POLISHED ALUM.



**Available on V8 only*



STANDARD EQUIPMENT

| EQUIPMENT DESCRIPTION | QP V6 AWD | QP V8 RWD |
|--|--------------|--------------|
| PERFORMANCE | | |
| Engine | 3.0 LITER V6 | 3.8 LITER V8 |
| Induction | TWIN TURBO | TWIN TURBO |
| Horsepower | 404 | 523 |
| ZF 8-Speed Automatic Transmission | STD. | STD. |
| Sport Skyhook Suspension | STD. | STD. |
| EXTERIOR | | |
| Power Sunroof | STD. | STD. |
| Metallic Paint | STD. | STD. |
| Adaptive Bi-Xenon Headlights with Washing System | STD. | STD. |
| Full LED Tail Lights | STD. | STD. |
| Heated Windshield Washer Nozzles | STD. | STD. |
| INTERIOR | | |
| Satin Ash Burl Wood Trim (Brown) | STD. | OPT. |
| High Gloss Erable Wood Trim | OPT. | STD. |
| 8-Way Power Front Seats with Heating | STD. | STD. |
| Adjustable Foot Pedals | STD. | STD. |
| Active Shift Paddles on Steering Column | OPT. | STD. |
| Leather Covered 3-Spoke Steering Wheel | STD. | STD. |
| 3-Place Rear Bench Seat with 3 Headrests | STD. | STD. |
| Rear Bench Seat - Heated | OPT. | STD. |
| Power Rear Side Sunblinds | STD. | STD. |
| Power Rear Sunblind | OPT. | STD. |
| Rear Air Ducts | STD. | STD. |
| 3 x 12V Outlets in Cockpit | STD. | STD. |
| 4 Cup Holders (2 Front, 2 Rear) | STD. | STD. |
| Analog Maserati Clock | STD. | STD. |
| Seat Belt Pilot Light | STD. | STD. |
| WHEELS | | |
| 19-inch Design Wheels with 245/45 R19 Front, 275/40 R19 Rear Tires | STD. | OPT. |
| 20-inch Design Wheels with 245/40 R20 Front, 285/35 R20 Rear Tires | OPT. | STD. |
| 18-inch Collapsible Spare Wheel | STD. | STD. |

2014 QUATTROPORTE STANDARD EQUIPMENT



MASERATI

STANDARD EQUIPMENT

| EQUIPMENT DESCRIPTION | QP V6 AWD | QP V8 RWD |
|--|-----------|-----------|
| COMFORT & CONVENIENCE | | |
| Dual Zone Automatic Climate Control | STD. | STD. |
| Cruise Control | STD. | STD. |
| Key-Less Entry/Starting System | STD. | STD. |
| Homelink 3-Channel Remote Garage Door Opener | STD. | STD. |
| Multifunction Steering Wheel | STD. | STD. |
| Night Design Ambient Lighting System | STD. | STD. |
| TECHNOLOGY | | |
| Maserati Sound System | STD. | STD. |
| Navigation with 8.4-inch Touch Screen Display (Maserati Touch Control) | STD. | STD. |
| Alarm System | STD. | STD. |
| Bluetooth Hands-Free Communication System | STD. | STD. |
| Color Instrument Cluster Display | STD. | STD. |
| Power Adjustable Side Mirrors | STD. | STD. |
| Autodimming Mirrors | STD. | STD. |
| Rain Sensor | STD. | STD. |
| USB Charging Port for Mobile Devices - Front & Rear | STD. | STD. |
| Speed-Sensitive Power Steering | STD. | STD. |
| BRAKES | | |
| Brake Calipers in Black (other colors available) | STD. | STD. |
| Electronic Parking Brake | STD. | STD. |
| Brake Assist System (BAS) | STD. | STD. |
| Automatic Hill Holder | STD. | STD. |
| Dual Cast Braking System (front - 360 mm); Cast-Iron (rear - 350 mm) | STD. | ---- |
| Performance Dual Cast Braking System (front - 380 mm), (rear - 350 mm) | ---- | STD. |
| SAFETY | | |
| Rear Parking Camera | STD. | STD. |
| Front and Rear Parking Sensors | STD. | STD. |
| Maserati Stability Program (MSP) | STD. | STD. |
| Tire Pressure Monitoring System | STD. | STD. |



OPTIONAL EQUIPMENT

| MODIS CODE | EQUIPMENT DESCRIPTION | QP V6 AWD | QP V8 RWD |
|----------------------------------|--|-----------|-----------|
| EXTERIOR | | | |
| | Solid Paint (Black, White) - No Cost | OPT. | OPT. |
| Q210 | Metallic Paint (Silver) - No Cost | OPT. | OPT. |
| Q58B | Mica Paint (Silk Black, Deep Blue) - No Cost | OPT. | OPT. |
| Q241 | Metallescent Paint (Bronze, Beige) | OPT. | OPT. |
| INTERIOR | | | |
| Q5KW | Alcantara Headliner | OPT. | OPT. |
| Q68V | High Gloss Ebony Wood Trim | OPT. | OPT. |
| Q5VF | Black Leather Steering Wheel with carbon fiber insert. (heated steering wheel not avail) | OPT. | OPT. |
| Q68W | Open Pore Beige Wood Trim (Satin Finish) | OPT. | OPT. |
| Q156 | Carbon Fiber Trim in Satin Finish | OPT. | OPT. |
| Q319 | Leather Steering Wheel with Wood Insert | OPT. | OPT. |
| Q5ZK | Heated Leather Steering Wheel with Wood Insert | OPT. | OPT. |
| Q5KV | Leather Steering Wheel with Carbon Fiber Insert | OPT. | OPT. |
| Q727 | Extended Fine Grain Drilled Leather - requires ventilated front seats (Q727) & two individual comfort luxury seats with center console (Q185) | OPT. | OPT. |
| Q728 | Extended Fine Grain Interior | OPT. | OPT. |
| Q732 | Extended Fine Grain Leather Interior + Alcantara | OPT. | OPT. |
| Q4CS | Inox Sport Foot Pedals with High Grip Rubber Inserts | OPT. | OPT. |
| COMFORT & CONVENIENCE | | | |
| Q559 | Front Ventilated Seats are required with Extended Fine Grain Drilled Leather (Q727) | OPT. | OPT. |
| Q204 | Four Zone Automatic Climate Control | OPT. | OPT. |
| Q5IX | Extended Key-Less Entry Including Rear Doors | OPT. | OPT. |
| Q185 | Two Individual Comfort Luxury Rear Seats with center console requires extended fine grain drilled leather (Q727) | OPT. | OPT. |
| Q179 | Foldable Rear Tables | OPT. | OPT. |
| Q989 | Smoking Kit with Refined Ashtray for Cup-Holder Fitting | OPT. | OPT. |
| TECHNOLOGY | | | |
| Q4JF | Bowers & Wilkins 1280 Watt, 15 speakers - Premium Sound System | OPT. | OPT. |
| QRS7 | Wi-fi Vehicle Hot Spot | OPT. | OPT. |
| QATI | Rear Seat Entertainment System | OPT. | OPT. |

2014 QUATTROPORTE OPTIONAL EQUIPMENT



OPTIONAL EQUIPMENT

| MODIS CODE | EQUIPMENT DESCRIPTION | QP V6 AWD | QP V8 RWD |
|---------------|--|-----------|-----------|
| BRAKES | | | |
| Q4TB | Brake Caliper in Blue | OPT. | OPT. |
| Q6AJ | Brake Caliper in Polished Finish | N/A | OPT. |
| Q4TA | Brake Caliper in Red | OPT. | OPT. |
| Q58I | Brake Caliper in Silver | OPT. | OPT. |
| WHEELS | | | |
| Q431 | 19-in Design Wheels, Front: 245/45 R19, Rear: 275/40 R19 | STD. | OPT. |
| Q439 | 20-in Design Wheels, Front: 245/45 R20, Rear: 285/35 R20 | OPT. | STD. |
| Q433 | 20-in Design wheels, Front 245/45 R20, Rear: 285/35 R20 | OPT. | OPT. |
| Q241 | 21-in Design Wheels, Front: 245/35 R21, Rear: 285/30 R21 | OPT. | OPT. |

**Information is preliminary and subject to change without notice.*





| PREMIUM PACKAGE | MSRP |
|--------------------------------------|--------------------------|
| Alcantara headliner | |
| Gloss wood-leather steering wheel | 410 V6 AWD 530 V8 RWD |
| High-gloss wood trim (std on 530 V8) | |
| Red brake calipers | |

| HEATING PACKAGE | MSRP |
|-----------------------|--------------------------|
| Heated Steering Wheel | 410 V6 AWD 530 V8 RWD |
| Heated Rear Seats | |
| Power RearSunblind | |

| LUXURY PACKAGE | MSRP |
|--|--------------------------|
| Full Leather Interior | |
| 4-Zone Climate Control | 410 V6 AWD 530 V8 RWD |
| Ventilated Front Seats w/Drilled Leather | |
| Heated Steering Wheel* | |

*Heated steering wheel not available on 410 V6, already included in heating package.

| SPORT 20 PACKAGE | MSRP |
|------------------------------------|--------------------------|
| Red Brake Calipers | |
| 20-inch Quattroporte Design Wheels | 410 V6 AWD 530 V8 RWD |
| Inox Sport Pedals | |
| Active Shifting Paddles | |

| SPORT 21 PACKAGE | MSRP |
|-------------------------------------|--------------------------|
| Red Brake Calipers | |
| 21-inch Vesuvio Design Wheels* | 410 V6 AWD 530 V8 RWD |
| Inox Sport Pedals | |
| Active Shifting Paddles (STD on V8) | |

*21-inch Vesuvio wheels come with summer performance tires only. All-season tires not available.

2014 QUATTROPORTE ENGINE SPECIFICATIONS



NEW MASERATI ENGINE

Developed by Maserati and produced by Ferrari in Maranello, the new 3.8 liter twin-turbo V-8 is the perfect expression of Maserati performance. The new V-8 provides high performance with 523 maximum horsepower and 524 ft-lbs of torque via gasoline direct injection and turbo overboost function. The engine delivers outstanding efficiency and vehicle range improved by +20% with a 0-60 mph time of under 4.7 seconds and a 190 mph top speed.



HIGHLIGHTS

- 3,798 cc V-8
- 523 HP / 524 ft-lb Torque (Overboost)
- Twin-turbos with intercooling
- Gasoline Direct Injection (GDI)
- Dual-Overhead Camshafts with 4 valves per cylinder
- Maximum torque available at 2,500 RPM
- 7,200 RPM Redline

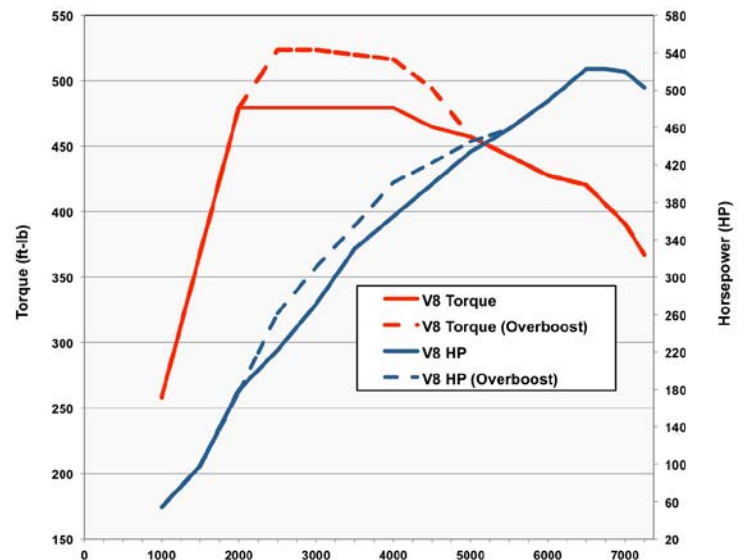



WWW.MASERATI.US

MASERATI NORTH AMERICA, INC. · 250 SYLVAN AVENUE · ENGLEWOOD CLIFFS, NJ 07632

1-877-MY MASERATI · DRIVEMASERATI@MASERATIUSA.COM

©2013 Maserati North America. All rights reserved. The illustrations and texts contained in this brochure are based on the information available at the time of printing and do not contain a description of specific characteristics of the car by the Manufacturer. Some models, equipment and accessories may not be available or may only become available after the car's launch on the market. Maserati reserves the right to modify colors, designs and technical features at any time and without prior notice. Contact your authorized Maserati Dealer for further details.

2018235