

Owner's manual

Ferrari _____
California





General remarks

This vehicle, which complies with EC homologation parameters, uses advanced technology and is capable of achieving high performance levels.

It is equipped with sophisticated active and passive safety systems (described below); these features and systems do not authorise the driver to take risks other than those involved in normal driving since their preventive and protective action is guaranteed only in certain conditions. Unless otherwise instructed specifically by **FERRARI** (see the Safety chapter), the deactivation of any of the vehicle's restraint systems is **PROHIBITED**.

While certain safety devices (e.g. the airbags) have been tested to ensure that they offer the highest possible levels of safety, they may nonetheless be hazardous in the event of failure by the driver or passenger to observe the instructions given by **FERRARI**. All occupants of the vehicle must be attentive at all times and take particular care when transporting passengers who are more susceptible to injury, such as children, disabled and elderly persons.

For safe driving, the following conditions must **ALWAYS** be met:

- the driver must be in perfect psycho-physical condition;
- road regulations (Road Regulations - Vienna Convention on Road Traffic that ended on 8 November 1968) must be strictly observed;
- common rules of caution must always be observed in relation to the quality/performance of the vehicle, driving conditions and contingent situations.

- Driving takes place in a naturally dangerous context where a number of different risk factors interact. For this reason, it is important to drive bearing in mind that others, whether they are pedestrians, motorcyclists or motorists, can make mistakes. Keeping a safe distance allows emergency measures to be taken.

Distractions and underestimating danger are the cause of most accidents.

- Caution and discipline are the basis of safe driving. Correct and careful use of a vehicle derives, above all, from respect for one's own safety and that of others as well as complying with road regulations. Only this respect will help you experience all the emotions that driving this car can offer you.

FERRARI recommends reasonable and careful use of the vehicle. The driver **MUST NEVER** allow passengers to increase the risks associated with driving (e.g. by not using safety systems such as seat belts) by failing to observe the mandatory safety rules that apply to both driver and passengers.

The vehicle **MUST NOT** be modified or tampered with for any reason whatsoever since, by so doing, the manufacturer's homologation and safety parameters will be modified.

The owner of the vehicle is obliged to perform careful maintenance on the vehicle in compliance with the recommended maintenance schedule.

General remarks

The driver must pay the utmost attention to the signals of the vehicle and, in particular, the warning lights on the dashboard and buzzers. Even when the warning lights do not indicate a situation of immediate danger, the driver must adopt a cautious attitude towards possible consequences/degeneration of the failure and other information given.

Even during routine operations, such as refuelling, precautions should always be taken and it is important to check that flammable liquid has not been spilled; these cautions must be observed even if the operation is performed by others. Similarly, before setting off make sure that the doors are closed by checking the warning lights and also manually. The driver must be fully acquainted with the vehicle and its controls in order to handle and drive it correctly. Acquaintance with the vehicle can be achieved/improved by attending the driving courses held by **FERRARI** which we strongly recommend.

The use of motor sports terms (such as F1, SPORT and RACE) is merely indicative of the competition-derived technology and suspension systems in the vehicle and does not endorse inappropriate behaviour on the road which does not comply with Traffic Regulations.

The above is merely a general outline of some of the problems described in detail in the rest of this manual.

Remember that national and international legislation requires that the driver of the vehicle must be capable of executing corrective and/or emergency manoeuvres at all times. The driver must also use any on-board information, communication and entertainment systems responsibly, especially when the vehicle is in motion. Examples of information, communication and entertainment systems are as follows: satellite navigation systems, traffic information systems (e.g. ITT), media players (e.g. iPod), telephones with Bluetooth connectivity, etc. (whether merely audio-based or with display).

The driver must bear in mind that on-board systems may be a cause of distraction when driving since they may require the driver to turn his or her attention away from the road for several seconds.

Aftermarket video entertainment systems for the passenger (e.g. TV) must be installed where they cannot distract the driver while the vehicle is in motion.

These systems may only be operated by the driver:

- in complete safety (stopping the vehicle before use if necessary);
- putting road safety first; for example, in poor or limited visibility, looking at a display with activated programmes can be distracting if you take your eye off the road even for a split second.

While the vehicle is in motion, the attention required to use on-board systems must never exceed the high level of attention required to drive safely in accordance with the Traffic Regulations;

- ensuring, if the previous vehicle owner has installed systems on the vehicle that are NOT APPROVED by **FERRARI** (car tuning), that they are fully compatible with the original vehicle equipment;
- in some countries, the use of entertainment/information systems is prohibited on vehicles when driving.

The driver is responsible for use of these entertainment/information systems with video screens if they are prohibited in the country where the vehicle will be driven.

Strict priority criteria must be used when driving a vehicle: you must not therefore take your attention and eye off the road excessively in order to perform driving operations. Operations that do not concern driving (e.g. changing dashboard functions), must be performed in maximum safety when the vehicle is stationary.

The aim of this Owner's Manual is to help you get the best value from your vehicle and to provide information on routine maintenance: we advise you to read it carefully before setting out. The Owner's Manual should be considered an integral part of the vehicle and must therefore always be kept on board.

Using the vehicle in a way that does NOT comply with the Owner's Manual not only exonerates **FERRARI** of any responsibility but also puts the person at great risk.

Updating

The high quality level of the vehicle is subject to constant technological improvements. Therefore, there may be differences between this manual and your vehicle.

The **FERRARI** Sales and Service Network will be pleased to provide you with all the information on any updates.

All specifications and illustrations contained in this manual refer to those resulting as of the printing date.

Spare parts

When replacing parts or topping up with lubricants and fluids, we recommend you use original spare parts and the lubricants and fluids recommended by **FERRARI**.

The **FERRARI** warranty is voided if ORIGINAL **FERRARI** Spare Parts are NOT used for repairs.

Warranty Booklet

Each new vehicle comes equipped with a "Warranty Booklet".

This contains the vehicle's warranty validity conditions.

This warranty does not affect the buyer's statutory rights as a consumer, which derive from binding legal norms in his or her favour, in the various states or countries or from European Union regulations, towards the Dealer.

The Warranty Booklet also contains the routine maintenance indicated in the "Maintenance Schedule"

Service

The information in this manual is necessary for the use and proper care of the vehicle. In addition, Customers will get maximum satisfaction and results from the vehicle if they carefully follow the instructions in it.

We recommend you have all the checks and services performed at **FERRARI AUTHORISED WORKSHOPS** since they have highly skilled staff and the necessary equipment.

Please refer to the "Sales and Service Organisation" manual for information on the location of the **FERRARI DEALERS** and **AUTHORISED SERVICE CENTRES**.

The **FERRARI TECHNICAL SERVICE DEPARTMENT** is at your complete disposal for any information and advice.

Consulting the manual

To facilitate reading the manual, the topics have been divided into sections and chapters.

To further facilitate consultation, each section is identified by a specific colour:

General

Provides general information about your vehicle.

Quick reference guide

Contains all the information you need when using the vehicle for the first time.

Safety

Describes the main safety systems in the vehicle.

About your Vehicle

Provides all necessary information for use of the vehicle.

Advice for Emergency Situations

Provides useful advice for solving problems that may occur.

Care of the vehicle

Provides advice for cleaning, care and routine maintenance of your vehicle.

Glossary

Explains the main technical concepts.

Table of Contents

Allows you to quickly identify and locate the information required.

Within the various sections, special attention must be paid to the parts marked as follows:

Warning



Extreme caution required: failure to comply with the instructions could constitute a serious risk to personal safety and vehicle protection!

Important note



Important note: a note containing instructions or information.

Environment



Warning for environmental protection: useful advice for protection of the environment.

DCT gearbox

Important note



The vehicle is equipped with an electro-hydraulically controlled gearbox system by means of paddles on the steering wheel.

The default setting for the DCT gearbox is always “Automatic” mode.

Every time the vehicle is started, the DCT gearbox is in “Auto easy exit” mode unless the vehicle was in “Automatic” mode when it was turned off.

To exit the “Auto easy exit” mode operate the **UP** or **DOWN** paddle (while the vehicle is moving) or press the **AUTO** button on the central console.

Important note



Although the system can be used in “Automatic” mode, it should not be considered an automatic gearbox and therefore, to use it correctly, always follow the instructions given in this manual on page 154.

Abbreviations/Acronyms

Some descriptions and terms with particular meanings are found in this manual in an abbreviated form:

| | |
|---------|--|
| A.C. | AIR-CONDITIONING |
| ABS | ANTI-LOCK BRAKING SYSTEM |
| ASR | ANTI-SKID REGULATION during acceleration |
| EBD | ELECTRONIC BRAKE-FORCE DISTRIBUTION |
| CST | STABILITY and TRACTION CONTROL |
| ECU | ELECTRONIC CONTROL UNIT |
| F1-Trac | traction control derived from the technologies used in the racing sector |
| | Launch strategy for a high performance standing start. |
| DCT | DUAL CLUTCH TRANSMISSION |

For an overview of the abbreviations contained in this manual, please see the **Glossary**.

Environmental protection

Environment



The following chapter contains useful advice for environmental protection.

FERRARI has designed and constructed a vehicle using technologies, materials and devices capable of reducing the harmful impact on the environment to a minimum.

Using your vehicle with respect for the environment will be your contribution towards environmental protection.

Fuel consumption as well as engine, gearbox, brakes and tyres wear mainly depend on two factors:

- use of the vehicle
- driving style.

Both factors are influenced by the driver.

Use of the vehicle

- Avoid using the vehicle for short trips.
- Check that the tyre pressure is correct.
- Check the fuel consumption.
- Proper periodic maintenance will contribute to preserving your vehicle in full working order and to protecting the environment. We therefore advise you to respect the service due dates indicated in the “MAINTENANCE SCHEDULE”.

Driving style

- Do not accelerate during the starting procedure.
- Do not warm up the engine when the vehicle is stationary.
- Drive prudently and keep a safety distance suited to the driving speed.
- Avoid sharp and frequent accelerations.
- Turn off the engine if the vehicle is kept stationary for long periods of time.
- Shift gears using only 2/3 of the speed permitted for each gear.

Important note



The vehicle is equipped with exhaust gas control and monitoring systems which must be always kept in full efficiency and controlled regularly.

End-of-life vehicle collection service

For many years, FERRARI has been globally committed to respecting and protecting the environment by constantly improving its manufacturing processes and developing increasingly eco-compatible products.

To ensure that its customers receive the best service possible, in compliance with environmental legislation and the requirements of EU Directive 2000/53/EC for end-of-life vehicles, FERRARI offers owners the possibility of consigning their end-of-life vehicles at no additional cost so that it can be disposed of.

The EU Directive states that the final owner of an end-of-life vehicle (ELV) must be able to consign his or her vehicle without incurring any costs as a result of its null or negative market value.

In almost all European Union member states, since 2007, ELV collection is free of charge regardless of the year of registration provided that the vehicle (and the engine and bodywork in particular) contains no additional waste.

To consign your end-of-life vehicle at no additional cost, please contact one of our dealers to ensure that the vehicle is collected, processed and recycled properly without harming the environment.

1. General

2. Quick reference guide

3. Safety

4. About your vehicle

5. Advice for Emergency Situations

6. Care of the vehicle

7. Glossary

8. Table of Contents



Vehicle keys

The vehicle is delivered with two identical keys that can be used for:

- central door locking;
- starting the vehicle;
- deactivating the alarm system;
- activating/deactivating the alarm;
- opening the luggage compartment.

Important note



If the keys are lost or stolen, you can request a duplicate from the FERRARI SERVICE NETWORK (see section “Duplicating the keys” on page 16).



Important note



Make sure you record the code numbers in the space provided in the “WARRANTY BOOKLET”.

Key codes

A **CODE CARD** is supplied with the keys. This card shows the following:

- the electronic code
- the mechanical code for the keys, to be given to the FERRARI SERVICE NETWORK if you request duplicates of the keys.

Warning



The code numbers on the **CODE CARD** must always be kept in a safe and protected place, not accessible to others.

Important note



In the event of a change of ownership, it is essential that the new vehicle owner is provided with all the keys and with the **CODE CARD**.

Alarm system

The Ferrari CODE system

The vehicle is equipped with an electronic immobiliser system (FERRARI CODE) which is automatically activated when the ignition key is removed.

The keys are equipped with an electronic device which transmits a coded signal to the FERRARI CODE ECU. Once this ECU has recognised the signal, it allows starting the engine.

Operation

Each time the ignition key is removed from the 0 position, the protection system activates the engine immobiliser.

- When starting the engine, press the **ENGINE START** button on the steering wheel:



- 1) If the code is recognised, the **CODE** warning light **A** on the instrument panel turns off when checking has terminated whereas the **EOBD** warning light **B** turns off when the engine is started once the **ECU** has completed its diagnostic cycle; In these conditions, the protection system has recognised the key code and deactivated the immobiliser.
- 2) If the **CODE** warning light **A** stays on, it means that the code has not been recognised. In this case, it is advisable to turn the key back to position **0** and then back to **II**. If the immobiliser device remains active, try with the other key provided.

Important note



If you still cannot restart the engine, contact the **FERRARI SERVICE NETWORK**.



- While driving, with the ignition key in position **II**:

- 1) If the **CODE** warning light **A** turns on, it means that the system is performing a self-diagnostic cycle. At the first opportunity, you can stop and test the system: switch off the engine by turning the ignition key to position 0, then turn the key back to position **II**. The **CODE** warning light **A** will turn on and should go off within one second. If the warning light stays on, repeat the procedure described previously leaving the key at 0 for more than 30 seconds.

Important note



If the problem persists, please contact the **FERRARI SERVICE NETWORK**.

- 2) If the **CODE** warning light **A** flashes, it means that the vehicle is not protected by the immobiliser.



Important note



Contact the **FERRARI SERVICE NETWORK** immediately to have all the keys stored in the system memory.

Important note



Each key supplied has its own specific code, which must be stored in the memory of the system control unit.

Duplicating the keys

If you request additional keys, provided that the conditions to satisfy your request are met, remember that the codes must be stored (up to a maximum of 7 keys) on all the keys. Contact the **FERRARI SERVICE NETWORK** directly and bring the following with you:

- all the keys in your possession;
- the **CODE CARD** for the **FERRARI CODE** system;
- a personal identity document;
- the documents proving ownership of the vehicle.

The codes of the keys that are not available when the new memorisation procedure is performed will be deleted from the memory, in order to prevent that any lost or stolen keys are used to start the vehicle.

Replacing remote control batteries

If you press one of the three buttons of the key and this does not activate the corresponding function, check for correct operation of the alarm system functions using the other remote control before replacing the batteries.

Replace the remote control batteries as follows:

- lever open the key cover **C** with a small screwdriver at the position indicated by the arrow;
- remove the battery **D** pushing in the direction indicated by the arrow to release it from the retainer cover **E**;
- fit a new battery of the same type, observing the indicated polarity;
- close the key cover **C**.

Important note



Do not use sharp tools to remove the cover and be careful to avoid damaging the remote control.

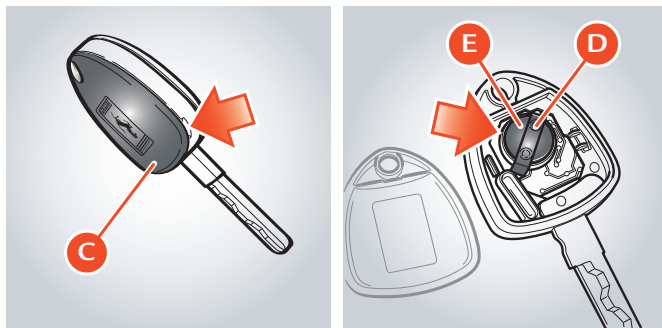

Electronic alarm

The electronic alarm system performs the following functions:

- remote control for central door locking/unlocking;
- perimeter surveillance, detecting if doors and lids are opened;
- motion surveillance, detecting intrusion into the passenger compartment;
- vehicle movement surveillance.

Activation

To activate the electronic alarm, press button **F** on the key:

- the direction indicators flash once;
- the system “beeps”
- the red LED on the dashboard flashes
- the central door locking system is activated and the doors are locked.

The system activates after approximately 25 seconds.

When the electronic alarm is activated, the user may request opening of the luggage compartment; in this case, the motion and anti-lift sensors are temporarily deactivated.

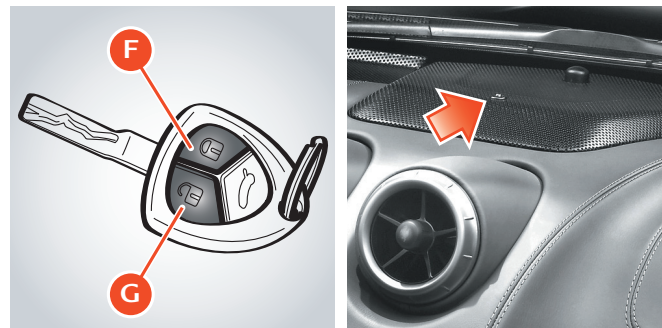

If the luggage compartment is then closed, the sensors will be reactivated.

The direction indicators and the red LED on the dashboard should be flashing 9 times when you activate the alarm system: this means that one of the doors or the front/rear lid is open or not properly closed and therefore is not protected by the perimeter surveillance. Check for correct closing of the doors, front/rear lid and close the open door or lid without deactivating the alarm system: the direction indicators flashing once indicate that now the door or the front/rear lid is closed properly and is protected by the perimeter surveillance.

Warning



If the direction indicators and the red LEDs on the dashboard flash 9 times when the alarm system is activated with doors, rear and front lids properly closed, it means that the self-diagnostic feature has detected a malfunction in the system. Contact the **FERRARI SERVICE NETWORK** to have the system checked.

Deactivation

To deactivate the alarm system press button **G** on the key:

- the direction indicators flash twice;
- the system beeps twice;
- the red LED on the dashboard switches off;
- the dome lights and the lights under the doors turn on;
- the central door locking system is deactivated and the doors are unlocked.

Pressing button **G** twice unlocks the doors and also turns on the low beams for 30 seconds.

The alarm system is off and it is therefore possible to get into the vehicle and to start the engine.

If the remote control battery is flat, to gain access to the vehicle, insert the key into one of the two door locks, then turn it to release the lock. The alarm siren will start to sound.

Start the vehicle following the standard procedures. The alarm siren will deactivate.

Deactivating the anti-lift alarm

Press button **H** to deactivate the anti-lift alarm system. When this function is deactivated, the LED on the button will flash for about 3 seconds and will then turn off.



Alarm memory

If the **CODE** warning light appears on the display when the vehicle is started, this means that an intrusion has been attempted.

The alarm system memory is reset by turning the ignition key.

In this case, the system will indicate the reason for the alarm activation according to the following priority:

- **LED off twice:** lifting sensor alarm
- **LED off three times:** door alarm
- **LED off four times:** luggage compartment lid alarm
- **LED off five times:** ignition key alarm.

The alarm system memory is reset by turning the ignition key.

Ministerial homologation

The electronic alarm system complies with EU regulations on electromagnetic compatibility and it is marked in compliance.

The homologation number is referred to with the following characters.

For those markets that require the transmitter and/or receiver marking, the homologation number is found on the component.

Satellite alarm system (optional)

The vehicle can be equipped, upon request, of a satellite alarm system. For information refer to the booklet “Quick Reference Nav Trak”, if the vehicle is equipped with satellite alarm system, in the vehicle documents.



Identification and homologation plates and labels

- A** Assembly number plate
- B** Low beam homologation label
- C** Homologation and ECE label
- D** Fuel label
- E** Paintwork label
- F** Oil check label
- G** Engine/gearbox oil type label
- H** TPMS present label
- I** Anti-freeze label
- L** Vehicle identification plate
- M** Warning label prohibiting child seat installation
- N** Airbag maintenance label
- O** Airbag warning label
- P** Engine type and number
- Q** Tyre pressure and type label
- R** Gearbox type and number
- S** Chassis number plate
- T** Retractable hard top warning labels

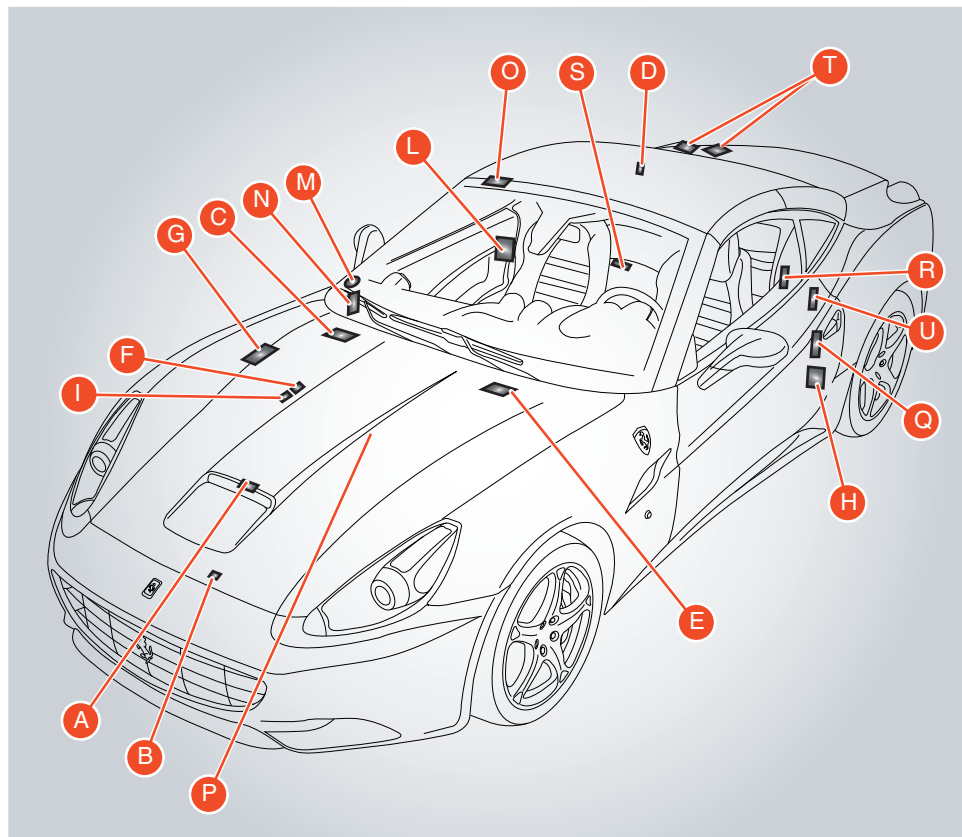

A Assembly number plate

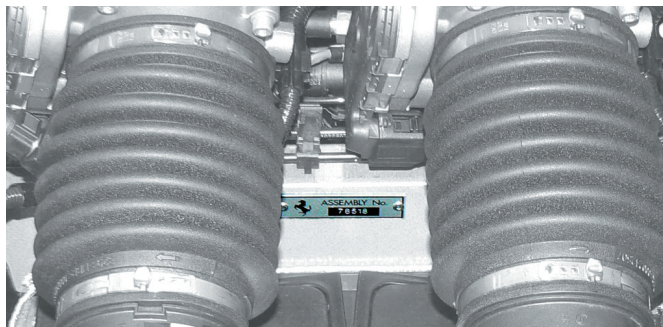

B Low-beam homologation label

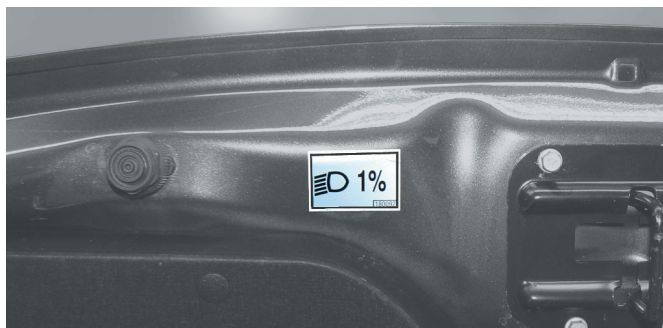

C Homologation and ECE label

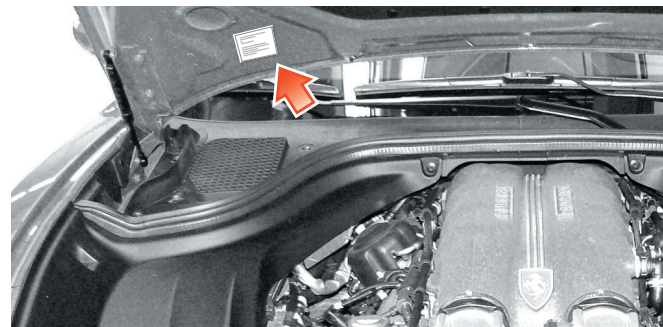

D Fuel label

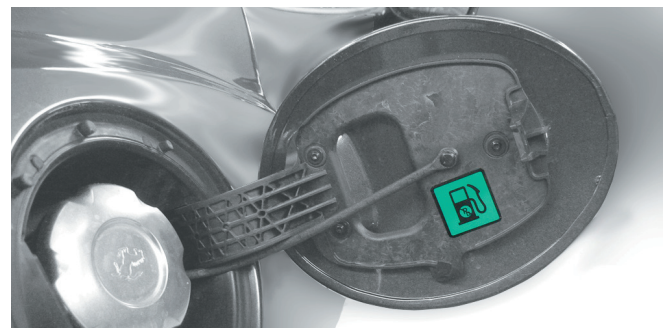

E Paintwork label



G Engine/gearbox oil type label



F Oil check label

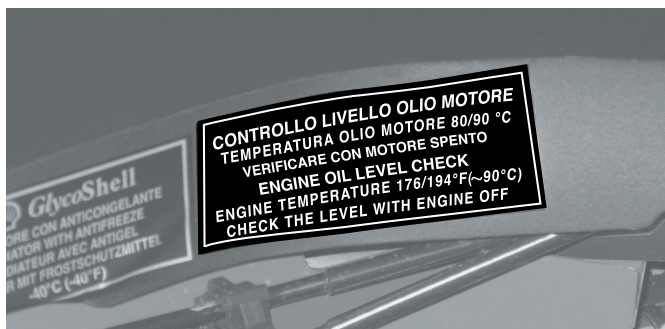

H TPMS present label

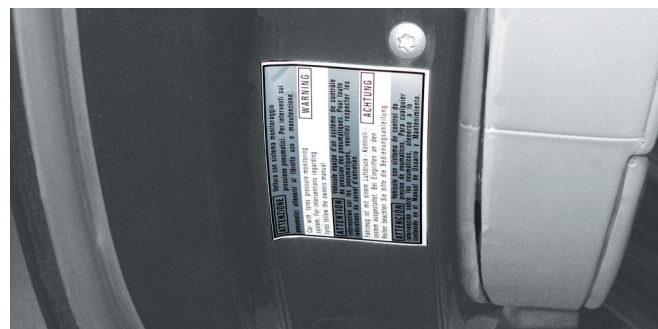

O Airbag warning label



Q Tyre pressure and type label



P Engine type and number

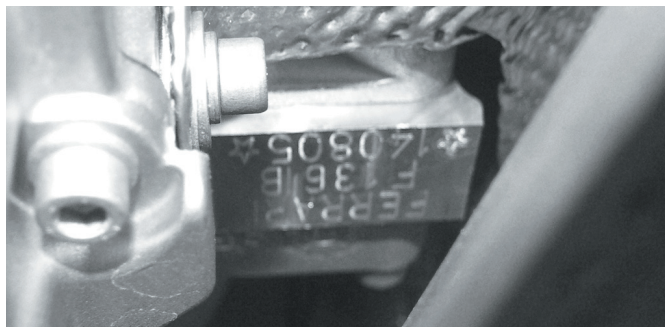

R Gearbox type and number

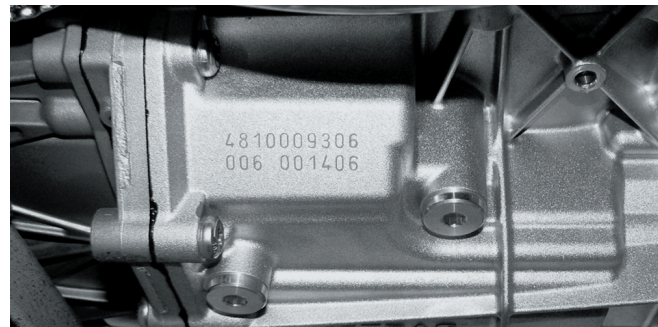

S Chassis number plate

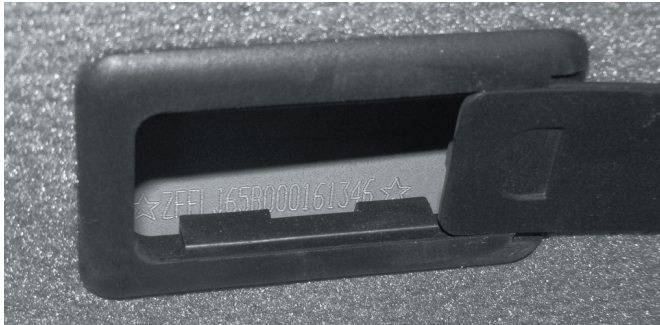

T Retractable hard top warning labels



Dimensions and weights

| | |
|-------------------|----------------------|
| Wheelbase | 2670 mm (78.74 in.) |
| Max. length | 4562 mm (157.48 in.) |
| Max. width | 1909 mm (75.15 in.) |
| Max. height | 1322 mm (52.04 in.) |
| Front track | 1630 mm (64.17 in.) |
| Rear track | 1605 mm (63.18 in.) |
| Front overhang | 952 mm (37.4 in.) |
| Rear overhang | 940 mm (37 in.) |
| Kerb weight (DCT) | 1780 kg (3916 lb.)* |

* considering the most favourable OPT combination

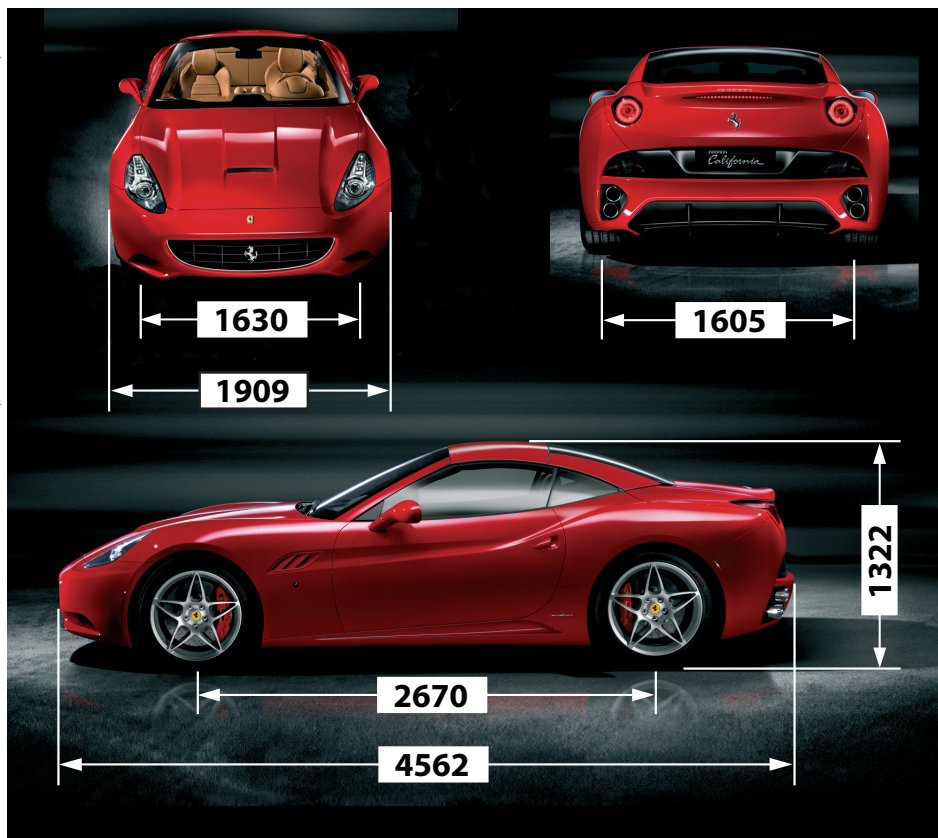

Main engine specifications

| | |
|---------------------------------------|----------------------|
| Type | F 136 IB |
| Number of cylinders | 8 |
| Cylinder sequence | V 90° |
| Cylinder bore | 94 mm |
| Piston stroke | 77.4 mm |
| Total displacement | 4297 cm ³ |
| Compression ratio | 12.2:1 |
| Maximum RPM (with limiting device) | 8000 RPM |
| Max. power (Directive 1999/99/EC) | 338kW (460 HP) |
| Corresponding RPM | 7750 RPM |
| Max. power (Directive 1999/99/EC) | 485 Nm |
| Corresponding RPM | 5000 RPM |

Consumption and CO₂ emissions

| EC Directive 1999/100 | l/100 km | g/km |
|--------------------------|----------|------|
| City cycle | 19.4 | 443 |
| Motorway | 9.4 | 215 |
| Average fuel consumption | 13.1 | 299 |

Transmission ratios

| Gearbox ratios | Differential/bevel gear pair ratio |
|----------------|------------------------------------|
| 1 = 2.822 | |
| 2 = 2.053 | |
| 3 = 1.379 | 4.444 |
| 4 = 1.091 | |
| 5 = 0.966 | |
| 6 = 0.788 | |
| 7 = 0.651 | |
| R = 2.368 | |

Performance

| | 0 - 100 km/h | 0 - 400 m | Max. speed |
|----|--------------|-----------|------------|
| F1 | 3.9 s | 12.2 s | > 310 km/h |

Electrical system

| Supply voltage | Alternator |
|-----------------------------|-----------------------|
| 12 V | Nippondenso 150 A SC2 |
| Battery | Starter motor |
| Fiamm 12V - 100 A/h - 850 A | Nippondenso |

Wheel rims and tyres

Wheel rims

| Front | Rear | Spare wheel |
|------------|-------------|--------------|
| 8" J x 19" | 10" J x 19" | 4.5" J x 20" |
| 8" J x 20" | 10" J x 20" | 4.5" J x 20" |

Tyres approved by Ferrari

| | | | | <i>Inflation pressure (cold)</i> | | |
|-----------------------|-------------|-------------|-------------|----------------------------------|-----------------|-----------------|
| | Front | Rear | Spare wheel | Front | Rear | Spare wheel |
| Pirelli P Zero | 245/40 ZR19 | 285/40 ZR19 | 145/60 ZR20 | 2.40 bar | 2.20 bar | 4.20 bar |
| Bridgestone | 245/40 ZR19 | 285/40 ZR19 | 145/60 ZR20 | 2.40 bar | 2.20 bar | 4.20 bar |
| Michelin | 245/40 ZR19 | 285/40 ZR19 | 145/60 ZR20 | 2.40 bar | 2.20 bar | 4.20 bar |

Optional tyres

| | <i>Inflation pressure (cold)</i> | | | |
|--------------------------------------|----------------------------------|--------------|-----------------|-----------------|
| | Front | Rear | Front | Rear |
| Pirelli P Zero | 245/35 ZR20 | 285/35 ZR 20 | 2.40 bar | 2.20 bar |
| Bridgestone RE 050 (Run Flat) | 245/40 ZR19 | 285/40 ZR19 | 2.40 bar | 2.20 bar |
| Bridgestone | 245/35 ZR20 | 285/35 ZR20 | 2.20 bar | 2.20 bar |

Winter tyres

| | <i>Inflation pressure (cold)</i> | | | |
|---------------------------------|----------------------------------|-------------|-----------------|-----------------|
| | Front | Rear | Front | Rear |
| Pirelli Winter Sottozero | 245/40 ZR19 | 285/40 ZR19 | 2.40 bar | 2.20 bar |

Correct tyre reading

Example: 245/40 ZR 19

245 = Nominal width (distance in mm from side to side)

40 = Height/width ratio as a percentage

Z = tyre that can support speeds of over 240 km/h

R = Radial tyre

19 = Diameter of rim in inches

The tyre manufacture date is included in the description of the tyre:

DOT ... 1008 means that the tyre was manufactured in the 10th week of 2008.

Correct rim reading

Example: 8" J x 19"

8 = width of rim in inches

J = shape of rim flange
(side projection where the tyre bead rests)

19 = rim diameter in inches
(corresponds to the diameter of the tyre to be fitted)

For further information on the tyres, see page 226.

Run Flat tyres (optional)

The vehicle can come equipped with “Run flat” tyres. This type of tyre has a reinforced side **A** which allows the vehicle to continue travelling at moderate speed

(80 km/h), even after a puncture, for a specific distance.

The instrument panel receives the “tyre puncture” information from the tyre pressure monitoring ECU, monitors the residual tyre life, and displays a warning in the dedicated area of the TFT display after 50 km.

After 100 km, a message warning the driver to stop the vehicle will be displayed (see “Tyre pressure and temperature monitoring system” on page 87).

Warning



Observing the recommended wheel alignment values is essential in order to obtain the best performance and the longest life of these tyres.

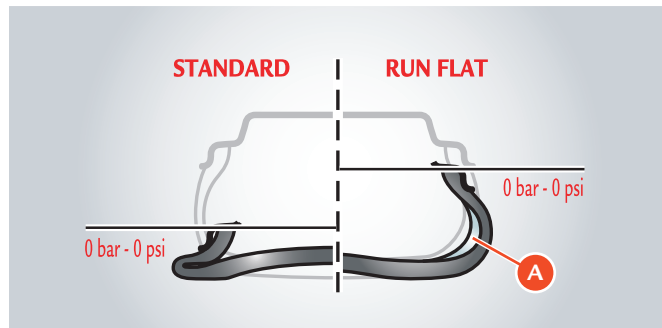



Warning



If you are going to use standard tyres on a vehicle that was originally equipped with “Run Flat” tyres, you must contact the **FERRARI SERVICE NETWORK** to have the dashboard reprogrammed and to prevent viewing warning messages on the TFT display.

Refilling

| <i>Parts to be refilled</i> | | <i>Quantity</i> | <i>Fill with:</i> | <i>Ref. Page</i> |
|---|---------------------------------|-------------------------|--|------------------|
| Engine | Total system capacity | 11 l |  Shell HELIX ULTRA SAE 5W-40 | 221 |
| | Oil level between Min. and Max. | 1.5 l | | |
| | Oil consumption | 1.0 ÷ 2.0 l/1,000 km | | |
| Gearbox and differential | | 4.9 l |  Shell TRANSAXLE 75W-90 GL5 | 223 |
| Clutch system and hydraulic controls | | 9.2 l |  Shell DCT-F3 | |
| Braking system | | - l | DONAX UB BRAKE FLUID DOT4 <i>Ultra</i> | 225 |
| Cooling circuit | | - l | GLYCOSHELL at 50% | 223 |
| Hydraulic steering system | | - l | DONAX TX | 224 |
| Steering box | | - g | | |
| Fuel tank | | 78 l | Unleaded fuel 95 RON. | 104 |
| Reserve | | 20 l | | |
| RHT system | Total system capacity | 0.4 l | Pentosin CHF 11S | - |
| | Oil level between Min. and Max. | 65 ml | | |
| Air conditioning and heating system | | | | - |
| Compressor | | 165 cc | PAG ISO 46 | |
| Coolant | | 500 ± 50 g | DELPHI RL 488 "R 134 A" | |
| Windscreen washer/headlight washer fluid tank | | - l | Mixture of water and glass cleaner | 226 |

1. General

2. Quick reference guide

3. Safety

4. About your vehicle

5. Advice for Emergency Situations

6. Care of the vehicle

7. Glossary

8. Table of Contents



Opening

Doors

When the doors are opened or closed, the windows will automatically move down approximately 2 centimetres (0.8 in.) and stop (broken line) in order to prevent collision with the door weather strip.

When the door is closed, the window automatically moves up until it meets the upper limit (weather strip).

Opening from the outside

Using the remote control, deactivate the alarm and the central door locking system, or turn the key in the lock to deactivate the central door locking system.

When pulling the handle to open the door, the window moves down approximately 2 centimetres. When the door is closed, it will move back up until it meets the upper limit.

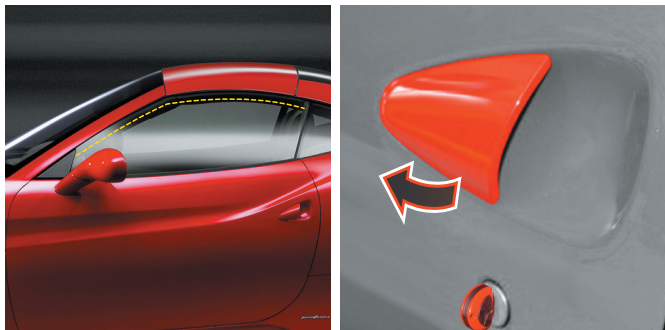

Locking and opening the doors from the inside

Both doors are locked by activating/deactivating button **A** on the dome light.

When using the handle to open the door, the window will move down to its “target position”. When the door is closed, it will move up until it meets the “upper weather strip”.

If the handle is operated without opening the door, the window will move down to its “target position” and stop, and if the door is not opened after 15 seconds, the window will move back up until it meets the “upper weather strip”.

Therefore, the handle must be released and pulled again in order to open the door.

When the opening handle is operated, both doors are unlocked.

Underdoor light

Each door has an underdoor light. This light comes on automatically when the door is opened.



Retractable hard top

Warning



For safety reasons, the retractable hard top can only be opened and closed when the vehicle is stationary.

Warning



The roof must be opened or closed whilst remaining correctly seated in the driver's seat.

Warning



Before activating the roof and while it is in motion, always check that people and objects are at a safe distance from the moving parts of the roof. In the event of danger, release the roof switch; all movement will stop immediately.

Warning



Before operating the retractable hard top, make sure that the backrest of the child restraint system is set to its minimum height.

Important note



If distance **B** is less than 400 mm, the parking sensors will not allow the roof to open or close.

The preliminary steps for opening and closing the retractable hard top are:

- vehicle must be stationary
- luggage compartment must be closed
- battery voltage must not be below 11 volts
- partition between luggage compartment and folded roof compartment must be in the correct position, fully pushed back and fastened
- check there is adequate space heightwise and in the rear of the vehicle: the minimum available height **A** must be 1700 mm, the minimum distance **B** of an obstacle from the rear must be more than 400 mm
- ignition key in position II and engine running.

Important note



We recommend operating the retractable hard top with the engine running.

- no overheating of hydraulic system.

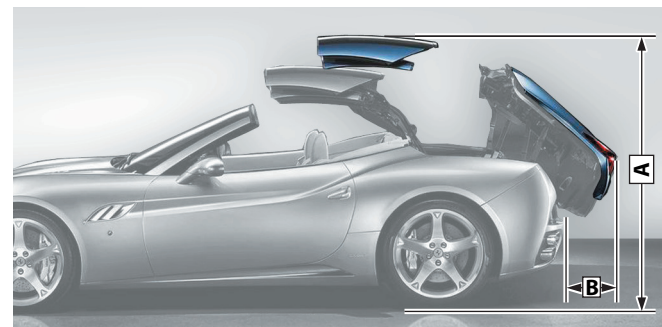

If one or more conditions are not met, the following message will appear on the TFT display.

Important note



Before opening or closing the hard top, refer to “Placing suitcases in the luggage compartment” on page 177.

Roof opening using switch

Warning



Before opening the roof, ensure that the top of the roof and the rear screen are dry to avoid water entering the passenger compartment or luggage compartment.

Pull back the switch **A** on the central console and hold until the operation has been completed.

The operation in progress will be indicated by a message on the TFT display (see page 112).



At the end of the opening cycle, an acoustic signal will indicate the end of operations and the corresponding message will appear on the TFT display (see page 112).

Important note



Throughout all these phases, the side windows cannot be activated.

For further information, see pages 111-112.

Roof closing using switch

Push forward the switch **A** on the central console and hold until the operation has been completed.

The operation in progress will be indicated by a message on the TFT display.

At the end of the closing cycle, an acoustic signal will indicate the end of operations and the corresponding message will appear on the TFT display (see page 113). The switch can be released.

For further information, see pages 112-113.



Controls overview

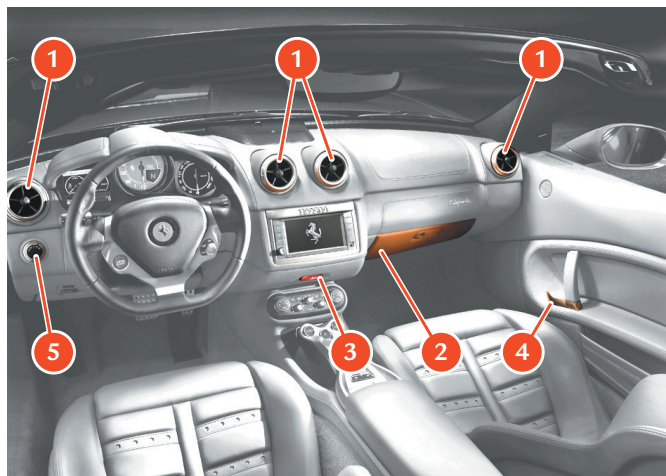

| Ref. | Control | Page |
|------|-------------------------------|------|
| 1 | Adjustable air vents | 175 |
| 2 | Glove compartment | 176 |
| 3 | Hazard warning lights control | 47 |
| 4 | Door opening handle | 102 |
| 5 | Light switch | 117 |

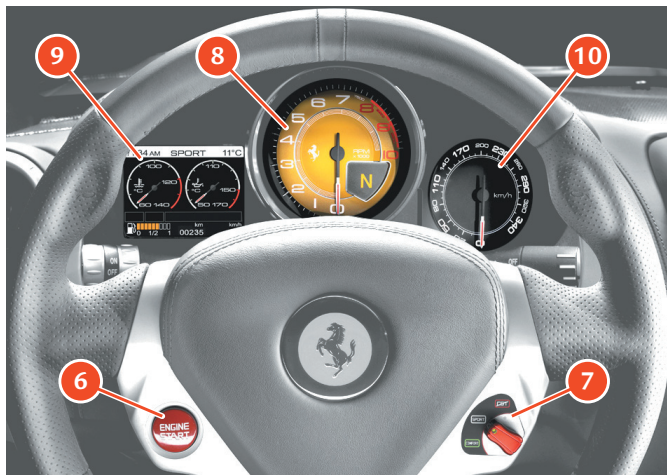

| Ref. | Control | Page |
|------|--------------------------------------|---------|
| 6 | “ENGINE START” button | 146 |
| 7 | “Manettino” control | 146-164 |
| 8 | Rev counter and “DOT MATRIX” display | 144 |
| 9 | “TFT” display | 122 |
| 10 | Speedometer | 109-144 |

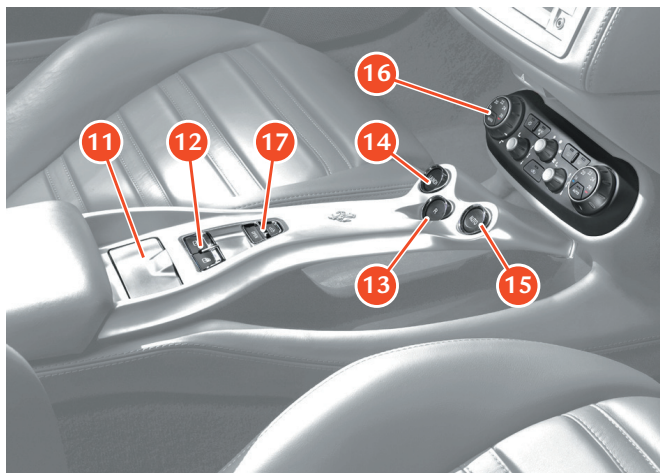

| Ref. | Control | Page |
|------|--|------|
| 11 | Ashtray | 176 |
| 12 | Power window controls | 106 |
| 13 | “R” reverse control (*) | 157 |
| 14 | “Launch” control (*) | 166 |
| 15 | “AUTO” control (*) | 159 |
| 16 | Air conditioning and heating system controls | 173 |
| 17 | Retractable hard top closing control | 111 |

Adjustments

Seats

Correct adjustments are very important for a better driving comfort and for the maximum efficiency of the passive safety systems.

Warning



Never adjust the seat while driving; you may lose control of the vehicle. Adjust the driver's seat only when the vehicle is stationary.

The seat position can be electrically adjusted using the special controls.

Three adjustments are possible using control **E**: forward/backward, height, inclination (tilting).

For further information, see page 167.

Seat back rake adjustment

For further information, see page 168.



Lumbar support and side width adjustment

Use control **F** to adjust the lumbar support.

Use control **G** to pneumatically adjust the width of the backrest sides and the seat cushion.

For further information, see page 168.

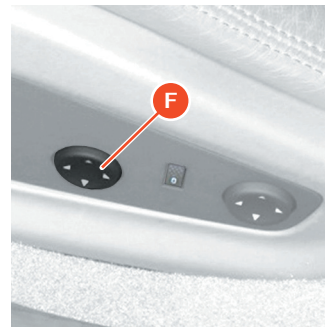

Tilting the backrest

To tilt the seat, pull lever **L** up and push the backrest towards the front of the vehicle.

For further information, see page 169.

Warning



Backward/forward adjustment must allow for the fact that airbag devices are placed in front of the driver and the front passenger (see page 74).

Correct adjustment ensures there is adequate space between the airbag and the person (see page 74).

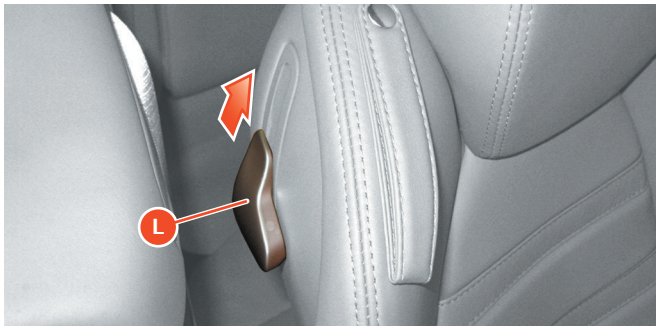

Headrest adjustment

To lower the headrest, press button **M**.

Place the headrest at a height that corresponds to the height of the occupant. To raise the headrest, simply pull it up.

Seat heating system (optional)

For further information, see page 170.

Driver's seat position memory (optional)

This device allows you to memorise and recall three different seat positions.

For further information, see page 168.

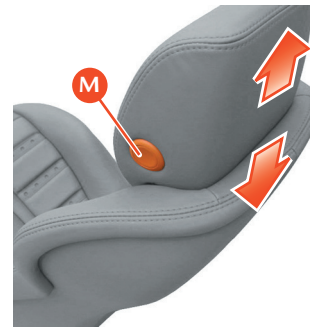

Steering wheel

The steering wheel is electrically adjustable for rake and reach. It can only be adjusted if the ignition key is in position **II**.

Move control **A** (to the left of the steering column) in the four directions to adjust the steering wheel.

The steering wheel position is memorised, together with the position of the external rear-view mirrors, when the driver's seat position is stored.

Warning



Do not adjust the steering wheel while driving.

To help the driver when entering or exiting the vehicle, the steering wheel is lifted automatically.

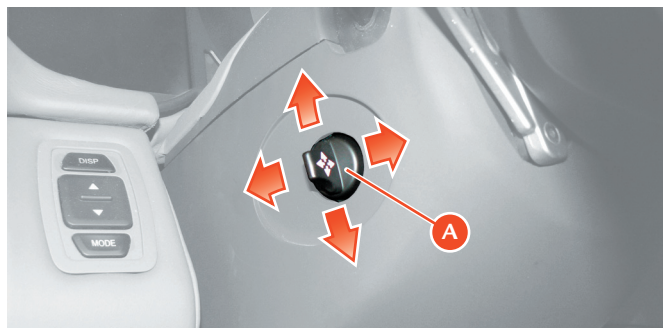

Rear-view mirrors

Internal electrochromic mirror

The internal electrochromic mirror automatically darkens to reduce the dazzling effect of the reflected light on the driver. The speed with which the mirror darkens depends on the intensity of the light.

External rear-view mirrors

These mirrors can be electrically adjusted using the control **B** (with the ignition key in position **II**) and are equipped with defogging elements.

- 1) Mirror selection: using control **B** select the mirror you wish to adjust (right- or left-hand).
- 2) Mirror positioning: move control **B** in the four directions (up - down - right - left) to adjust each mirror.



Once adjustment is complete, move the control **B** into the upper central position, where it will be locked, in order to avoid changing the setting inadvertently.

The mirrors will yield in both directions in the event of a collision: if necessary, the mirrors can be pushed both backwards and forwards.

Warning



The mirrors must be always positioned correctly while driving.
Do not adjust the mirrors when the vehicle is moving.

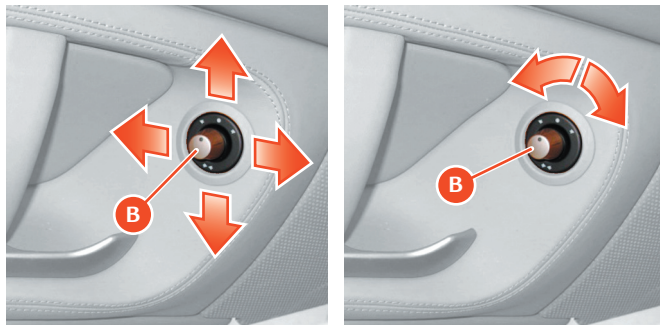

Seat belts

Warning



The seat belts must be properly adjusted and buckled at all times!

Correct use of the seat belts can reduce the risk of serious injury in the event of an accident or if the vehicle overturns.

Do not use any devices (spring clips, locks, etc.) that could keep a seat belt from fitting properly.

Fastening the seat belts

After positioning the seat correctly;

- Grip the latch plate **A**, slowly pull the belt and insert the latch plate into the buckle **B** (if the belt locks while you are pulling it out, let it wind back briefly and pull it out again without jerking).

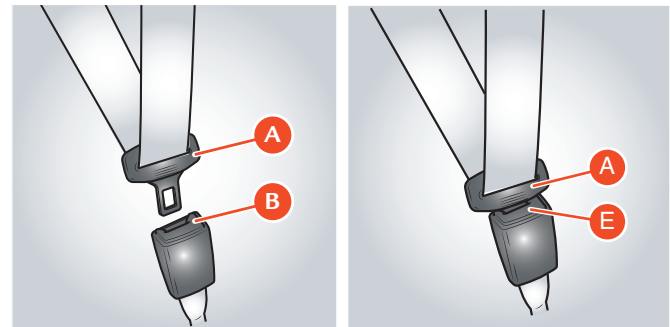

- Make sure that it has clicked into the locked position.
- Position the seat belt correctly.

Warning



To position the front seat belt correctly, make sure that it passes through the loop **C**, as shown in the figure.

If the driver's seat belt is not fastened, when you turn the ignition key to position **II**, the warning light on the instrument panel lights up and remains lit as long as the seat belt is not fastened.

Unfastening the seat belts

- Push the release button **E**.
- Guide the latch plate **A** back to its rest position.

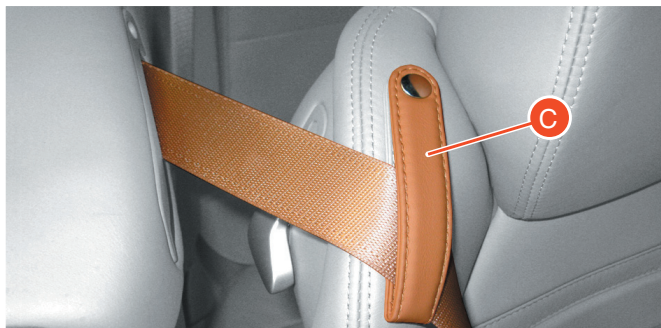

Warning



Do not allow children to be held on a passenger's lap using only one seat belt for both of them.

Warning



Remember that, in the event of a violent impact, passengers in the rear seats who are not wearing seat belts are not only subject to personal injuries (they can be catapulted forward, hit the windscreen and be thrown out of the vehicle) but also constitute a danger to the passengers in the front seats.

Refer to the "Safety" chapter on page 60.

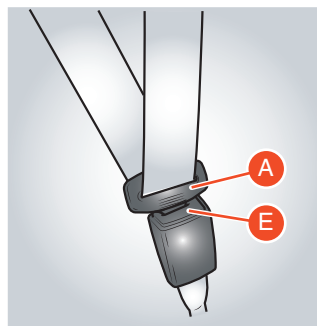

Driving

Ignition switch

The ignition key can be turned to 2 positions:

Position 0 - Stop

Engine off, key removable.

When the key is even only partially extracted, the steering column is locked.

The hazard warning lights and the parking lights can be activated.

To facilitate steering wheel release, turn the steering wheel slightly in both directions while turning the ignition key.

Position II - Ignition

Turning the key to this position, the TFT display will check the signals coming from the vehicle systems.

If no malfunctions are found after starting up, the words “**Check OK**” will be displayed.

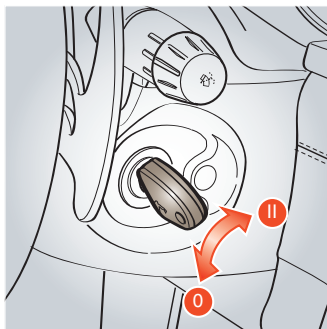

Warning



Never remove the key when the vehicle is moving!

The steering wheel will lock on the first steer.

Always remove the key from the ignition when you get out of the vehicle!

Never leave children unattended in the vehicle.

External lights and direction indicators

Light switch

Switch **A** has five positions:

0 Lights off

Running and number plate lights on

Low beams on

Parking lights

AUT Automatic operation of the external lights according to the ambient light.

High beams

To turn on the high beams when the light switch **A** is set to , push the left-hand lever **B** towards the dashboard.

Pull the lever **B** towards the steering wheel again to turn off the high beams and turn on the low beams.

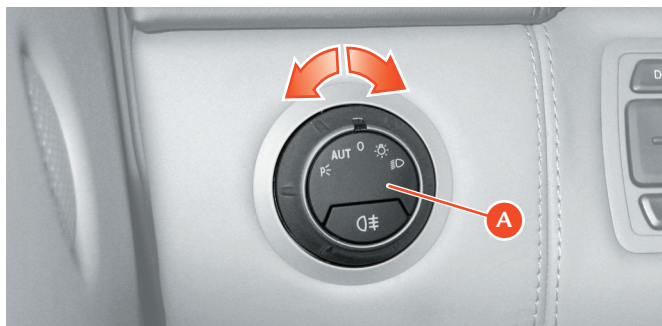

Important note



Follow the Road Regulations of the country you are travelling in for using the high beams.

Flashing the headlights

The headlights can be flashed by pulling the left-hand lever **B** towards the steering wheel.

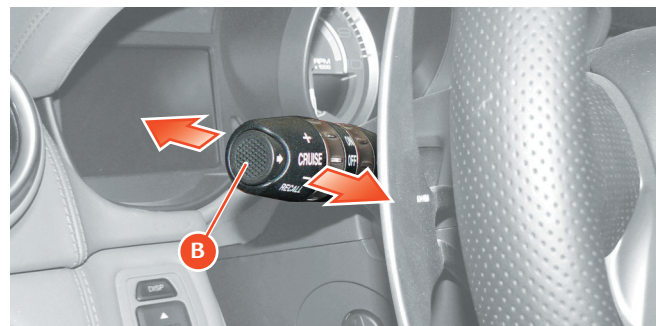

Direction indicators

When lever **B** is:

- moved up, the right-hand direction indicators are turned on;
- moved down, the left-hand direction indicators are turned on.

The lever returns to the neutral position automatically when the steering wheel is straightened.

To indicate a temporary lane change, requiring only the slightest turn of the steering wheel, the lever can be moved without clicking it into position (non-permanent position).

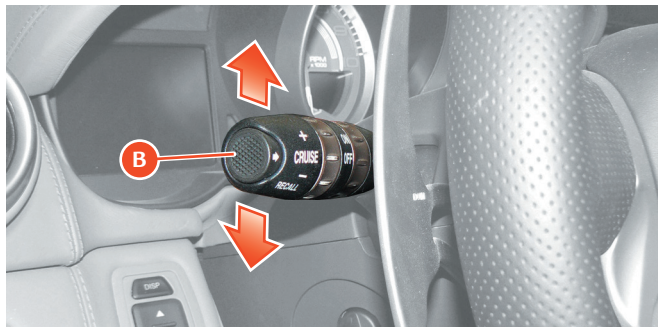

Rear fog lights

The rear fog lights are turned on only if the high beams or low beams are on when button **D** is pressed.

Important note



Use the rear fog lights only in poor visibility conditions.

Hazard warning lights

Press button **A** to turn on the hazard warning lights. All the direction indicators will start blinking intermittently. These lights will operate with the ignition key in any position.

When the lights are on, the relative warning lights on the instrument panel and the button flash.

To turn them off, press the button again.

For further information, see page 120.

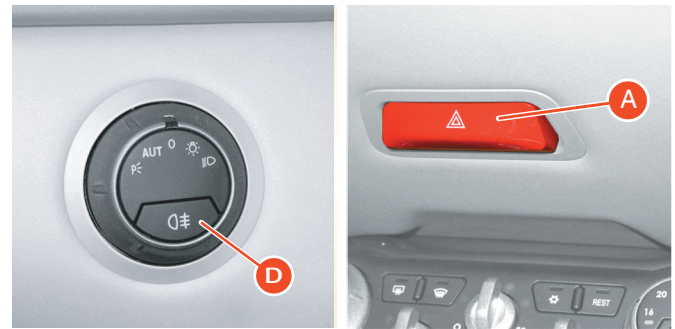

Starting and driving the vehicle (DCT gearbox)

System start-up

When the ignition key is turned to position **II** the DOT MATRIX gearbox display and failure warning light **A** are turned on. The warning light will turn off if no problems are detected within a few seconds.

The letter P (Parking) or N (Neutral) will remain highlighted on the display.

Important note



BEFORE YOU DRIVE

If the warning light **A** continues flashing without going off, switch off the system and wait for the gear display to go off before restarting.

If the failure persists, contact the **FERRARI SERVICE NETWORK**.



If the warning light **A** is faulty, a warning light will appear on the TFT display (see page 143) and this condition will be indicated by an acoustic alarm when the ignition key is turned to position **II**.

Warning



Contact the **FERRARI SERVICE NETWORK**.

Operation with the engine off

The vehicle is equipped with an electro-hydraulically controlled gearbox system by means of paddles on the steering wheel. The default setting for the DCT gearbox is always “Automatic” mode.

Every time the vehicle is started, the DCT gearbox is in “Auto easy exit” mode unless the vehicle was in “Automatic” mode when it was turned off.

To exit the “Auto easy exit” mode simply operate the UP or DOWN paddles (while the vehicle is moving) or press the AUTO button on the centre console.

Once the “System start-up” stage has been completed, the engaged gear will appear on the DOT MATRIX display:

- N** (Neutral)
- P** (Parking)
- R** (Reverse gear)
- 1** (1st gear)
- 2** (2nd gear), etc.



If the indication flashes (may also occur with N) it means that the gear is not perfectly engaged or disengaged; therefore, request N and then the desired gear.

Important note



Immediately release the **UP** and **DOWN** paddles and the button **R** after the display shows that the gear has been engaged; a prolonged manoeuvre will cause the failure warning light to turn on (see page 142 “Generic failure”) and trigger the buzzer.

Do not operate the system with the engine off to prevent the battery from discharging.

Also avoid unnecessary gearshifting when the engine is off, in order to prevent the system pump from overheating.



Important note



If the engine compartment lid is open or not properly closed, none of the gears can be engaged. When the vehicle is stationary, with the driver-side door open or not properly closed and the brake pedal released, the system disengages the gear engaged after approximately two seconds.

Starting the engine

- Make sure that the electric parking brake is applied and that the doors are closed.
- Hold the brake pedal down when starting the engine.

Warning



Do not press the accelerator pedal.

- Turn the ignition key to position **II** and wait for the “**Check OK**” icon to appear on the TFT display.
- If the “**Check OK**” symbol does not appear, turn the key back to position **0**, wait a few seconds and repeat the procedure.
- The vehicle is always in “Auto easy exit” mode, unless it was turned off with the gearbox in “Automatic” mode.

- Press the **ENGINE START** button (see page 146) and release it as soon as the engine starts.

- After the engine has started, the “**Check OK**” will appear.

Do not hold the **ENGINE START** button pressed down for a long time.

If the engine does not start, turn the key back to position **0** and wait for the gear display to go off before retrying.

Warning



Hold the brake pedal down while starting the engine.

If the engine fails to start after several attempts, check for one of the following causes:

- insufficient speed of the starter motor (flat battery)
- ignition device faulty
- electrical contacts faulty
- fuel pump fuses blown.

Warming up the engine

Do not run the engine at high speeds until the engine oil temperature has reached at least 65-70 °C (149-158 °F), approximately.

Starting the vehicle

With the engine started, the vehicle standing and the brake pedal pushed, pull the right-hand “UP” paddle towards the steering wheel to engage the 1st gear.

Release the brake pedal and press the accelerator to start off.

With the engine running and the vehicle stationary, you can change directly from 1st or 2nd gear to “R” (reverse) by pressing **R** and from reverse to 1st by moving the “UP” paddle.

Warning



If the “UP” and “DOWN” paddles are not working, the message “Depress brake pedal and press LAUNCH to engage gear” will appear on the TFT display. You can therefore engage the gear by pressing the Launch button (see page 166) and the brake pedal. In these cases, the Launch control function is not available. If the engaged gear was **R**, the Launch button must be pressed twice to engage the 1st gear.

Important note



When the reverse gear is engaged, an acoustic safety signal beeps intermittently for the entire time the **R** remains engaged.

If the system automatically selects 2nd gear when attempting to shift from **R** to 1st gear, this indicates that 1st gear has jammed. Therefore, this is not a malfunction, as it falls within the system operation logic. For the same reason, when shifting from 1st gear to “R”, the system will automatically engage “N” if the gear has jammed.

During prolonged stops with the engine running, it is advisable to keep the gearshift in “N”.

Important note



On downhill stretches, if you allow the vehicle to move forward in “N”, when “UP” is requested, the system will engage a gear in relation to the vehicle speed.

UP-shifting

Operate the right-hand **UP** paddle without releasing the accelerator pedal.

An **UP**-shift request is not accepted when engagement of the requested gear will force the engine to underrev or if an **UP**-shift is already in progress due to engine overrevving.

For further information, see page 148.

DOWN-shifting

Use the left-hand **DOWN** paddle, even without releasing the accelerator pedal.

A **DOWN**-shift request is not accepted if engagement of the requested gear forces the engine beyond a certain number of revolutions, depending on the gear requested, or if a **DOWN**-shift is already in progress because of underrevving.

For further information, see page 148.

“N” (Neutral) request

If necessary, **“N”** can be requested at any speed.

Subsequently, if an **“UP”** or **“DOWN”** shift is requested, the system will engage the gear most suited to the speed of the vehicle.

Stopping the vehicle

When the vehicle stops, the system automatically engages the **1st** gear (unless **“N”** has already been requested).

When the vehicle is stationary and the engine is running, hold the brake pedal down until ready to move off again.

Turning off the engine and deactivating the system

The engine can be switched off either with the gearbox in **“N”** or with a gear engaged.

After turning the ignition key from position **II** to position **0**, the display will remain on for a few more seconds to display the engaged gear. If the gearbox is in **“N”** a buzzer will sound.

Warning



Never leave the vehicle with the gearbox in **“N”**. Make sure that the letter **“P”** appears on the display.

For further information, see page 158.

1. General

2. Quick reference guide

3. Safety

4. About your vehicle

5. Advice for Emergency Situations

6. Care of the vehicle

7. Glossary

8. Table of Contents



FERRARI has designed and built a high performance vehicle. In order to take advantage of the safety systems described below, it is important to comply with the indicated regulations.

Special warnings

This vehicle has been built to comply with homologation, personal safety and environmental regulations.

To this high safety standard must correspond a careful and cautious behaviour of the driver.

Particular attention must be paid to:

- Overheated components. High temperatures develop in the engine compartment in proximity of the exhaust system. Do not park the vehicle on paper, grass, dry leaves or other flammable materials. They could catch fire if they come into contact with hot parts of the exhaust system. Do not fit other heat shields or remove those fitted on the exhaust system. Do not let flammable substances come into contact with the exhaust system.
- Moving parts on the vehicle such as belts, fans, etc. They must always be adequately protected. Do not remove the guards or operate on the moving parts without taking due precautions.
- Installations under pressure such as the braking system, the air-conditioning system, the cooling system and the lubrication system may create pressures inside them. Do not carry out any operation which may cause gas or liquids to spill out with the risk of injury to persons and damage to things.

Emissions

Warning



- The exhaust gas generated by the running engine may be hazardous, especially when in closed spaces. As well as consuming oxygen, the engine discharges carbon dioxide, carbon oxide and other toxic gases.
- The fuel is highly inflammable and emits vapours which may be noxious if inhaled.
Do not use naked flames or create sparks near the open fuel tank or in any other condition where fuel comes into contact with air.

Lubricants

Warning



- The oils used may also be flammable: take the same precautions as adopted for the fuel.

Flammable fluids

Warning



- The fluid in the battery is poisonous and corrosive. Do not let it spill out and come into contact with the skin, eyes or objects. Do not use naked flames or create sparks near the battery.

Fuel inertia switch

- See page 83.

Warning



Seat belts must be worn at all times and must be properly fastened and adjusted!

Correct use of the seat belts can significantly reduce the risk and severity of injury if an accident occurs or if the vehicle overturns.

Warning



For an effective restraining action, the seat belt must be fastened correctly with the seat backrest in the upright position.

The seat belt is fastened correctly when the upper part of the belt crosses the centre of the shoulder (not the neck) and the abdominal section is fitted over the hips (not the stomach).

Make sure it is not twisted and that it passes closely over your body; if not, in the event of a head-on collision, it may move and cause injury to the abdomen.

Avoid wearing bulky clothing that may interfere with the correct operating of the seat belts.

Warning



To increase driving safety, it is advisable to position the headrest so that the top is in line with the top of the head.

Warning



Each seat belt has been designed to protect only one occupant. If more than one person uses the same seat belt, the risk of injury in the event of an accident is increased.

Do not sit babies, small children or other persons on your lap.

If there is a collision, the weight of an adult may cause the child to be crushed by the seat belt causing severe or even fatal injuries.

Passive safety

The aim of the passive safety system is to reduce the risk and severity of injury if an accident occurs.

The vehicle has the following seat belts:

1. 3-point driver's seat belt with pretensioner and load limiting device (see page 60)
2. 3-point front passenger seat belt with pretensioner and load limiting device (see page 60)

and, only when rear seats are provided:

3. 3-point rear passenger seat belt with pretensioner and load limiting device (see page 63)
4. 3-point rear passenger seat belt with pretensioner and load limiting device (see page 63)

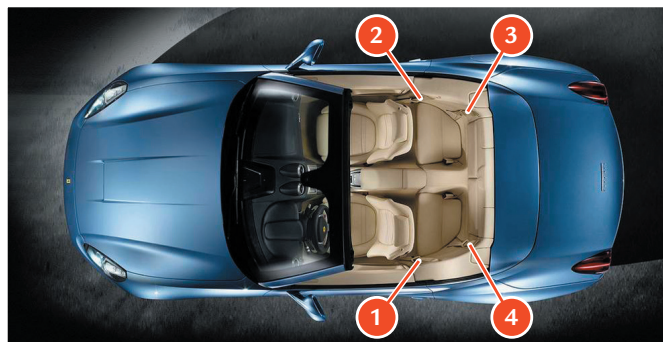

Warning



The auxiliary safety systems are not a substitute for seat belts. All occupants must always wear a seat belt. Correct use of the seat belts combined with use of the auxiliary safety systems offers maximum protection to occupants in various types of collision.

The vehicle also has the following auxiliary occupant protection system components (see also page 72 “Auxiliary occupant protection systems”):

5. front driver airbag (for operating functions see page 75)
6. front passenger airbag (for operating functions see page 75)
7. driver side head protection side airbag (head bag) (for operating functions see page 79)
8. passenger side head protection side airbag (head bag) (for operating functions see page 79)

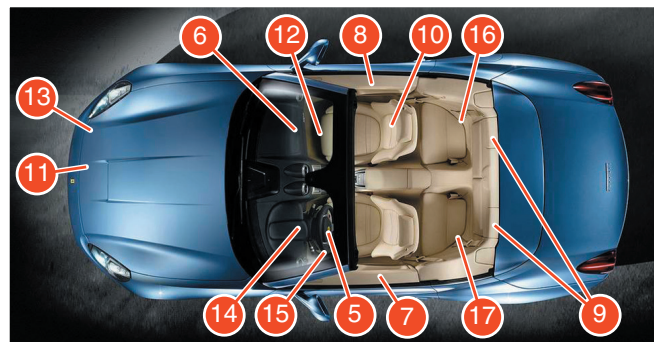

9. active roll bars (for operating functions see page 81)
10. seats (see page 167)
11. deformable body
12. occupant protection system ECU
13. ECU auxiliary sensors
14. instrument panel warning light (see page 74)
15. inertia switch

and, only in the presence of rear seats (see also page 66 “Child safety”):

- 16.a child seat lower anchorage system in the seat behind the front passenger
- 17.a child seat lower anchorage system in the seat behind the driver

The vehicle does not have upper anchorage systems for the installation of child seats.

Warning



The protective action of the airbags is always integrated with the seat belts and the pretensioners. The compulsory use of the safety belt is provided by the national regulations (in Italy, for example, by the Codice della Strada, i.e. Traffic Regulations).

Deformable body

The deformable body absorbs shock and distributes it over the entire structure of the vehicle allowing progressive deceleration.

The passenger compartment structure, on the other hand, has been designed for maximum resistance without undergoing deformation, with the aim of ensuring a protective survival cell for the occupants.

Active safety

The aim of the active safety system is to reduce the risk of accidents and reduce the severity of injury.

In addition to the features of the vehicle, manoeuvrability, stability and acceleration, there are other elements that can be considered as safety components:

- braking system
- air conditioning and heating system
- external lights
- buzzer and warning lights (flashing).

The braking system includes the mechanical brake system and the electronic stability and traction control system (ABS and EBD) which prevents the wheels from locking and always provides good manoeuvrability and stability.

The possibility of fast acceleration can in some cases get you out of dangerous situations. However, always use the accelerator with extreme caution. During acceleration of the driving wheels, the anti-skid system may help you in certain dangerous situations.

The air conditioning and heating system in the passenger compartment can add to driving comfort and keep you alert so that you can react quickly when necessary.

It is very important to be able to clearly see the road and to be seen, hence it is essential to turn on the external lights when the conditions so require.

Seat belts

Statistics show that when used correctly, seat belts reduce the risk of injury in various types of crashes including the risk of ejection from the vehicle and impact with the interior of the vehicle.

If left unfastened, seat belts offer absolutely no protection. Before every trip, always make sure that all occupants are wearing their seat belts.

Warning



Seat belts must be worn at all times and must be properly fastened and adjusted!

Correct use of the seat belts can reduce the risk of serious injury in the event of an accident or if the vehicle overturns.

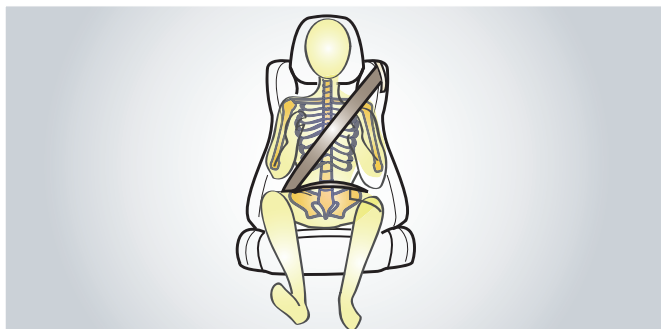

Warning



For an effective restraining action, the seat belt must be fastened correctly with the seat backrest in the upright position.

The seat belt is fastened correctly when the upper part of the belt crosses the centre of the shoulder (not the neck) and the abdominal section is fitted over the hips (not the abdomen).

Make sure it is not twisted and that it passes closely over your body; if not, in the event of a head-on collision, it may move and cause injury to the abdomen.

Avoid wearing bulky clothing that may interfere with the correct operating of the seat belts.

The seat belts for the front seats have a lap-shoulder belt with an automatic emergency-locking retractor and are fitted with a pyrotechnic-powered pretensioner and an automatic system that reduces the force applied to the occupant.

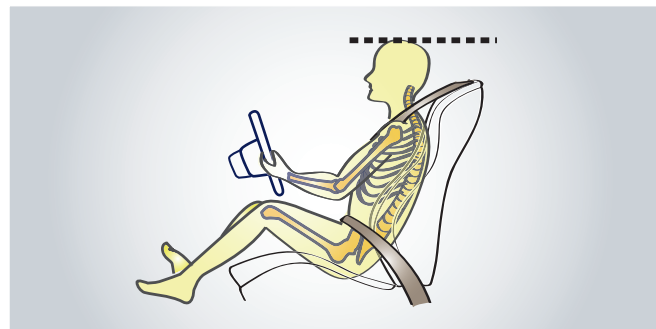

The seat belts for the rear seats have a lap-shoulder belt with an automatic emergency-locking retractor and are fitted with a pyrotechnic-powered pretensioner and an automatic system that reduces the force applied to the occupant.

Warning



To increase driving safety, it is advisable to position the headrest so that the top is in line with the top of the head.

Warning



Do not let the seat belts come into contact with cutting edges. They may get damaged and may consequently break in the event of a collision.

Warning



Each seat belt has been designed to protect only one occupant. If more than one person uses the same seat belt, the risk of injury in the event of an accident is increased.

The seat belt must never be passed around a baby, child or other person sitting on a passenger's lap.

Do not sit babies, small children or other persons on your lap.

If there is a collision, the weight of an adult may cause the child to be crushed by the seat belt causing severe or even fatal injuries.

Warning



Do not attach or pin anything onto the seat belts: they may get damaged and may consequently break in the event of a collision.

Warning



If a seat belt has come into contact with cutting edges or was somehow perforated, we recommend you have it immediately replaced by the FERRARI SERVICE NETWORK

Warning



Periodically check the condition of the seat belts. If the belt shows signs of wear, it must be checked by a qualified person and replaced if necessary. Contact the FERRARI SERVICE NETWORK immediately.

How to fasten seat belts

Warning



For an effective restraining action, the seat belt must be fastened correctly with the seat backrest in the upright position.

The seat belt is fastened correctly when the upper part of the belt crosses the centre of the shoulder (not the neck) and the abdominal section is fitted over the hips (not the abdomen).

Make sure it is not twisted and that it passes closely over your body; if not, in the event of a head-on collision, it may move and cause injury to the abdomen.

Avoid wearing bulky clothing that may interfere with the correct operating of the seat belts.

Once you have adjusted the seat correctly (see page 167);

- Grip the latch plate **A**, slowly pull the belt and insert the latch plate into the buckle **B** (if the belt locks while you are pulling it out, let it wind back briefly and pull it out again without jerking).

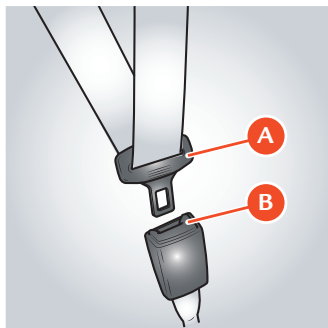

- Make sure that it has clicked into the locked position: hold the belt and pull it to check that the latch plate has been inserted correctly.
- Position the seat belt correctly.

Warning



To position the front seat belt correctly, make sure that it passes through the loop **C**, as shown in the figure.

If the driver's seat belt is not fastened, when you turn the ignition key to position **II**, the warning light **D** on the instrument panel lights up and remains lit until the seat belt is fastened.

55 seconds after a speed of 10 km/h is exceeded, a buzzer sounds warning the driver that the seat belt is not fastened.

When a speed of 20 km/h is exceeded, the buzzer activates immediately and stops after 90 seconds.



This acoustic signal is emitted only once, even if the vehicle speed goes above and below the above mentioned limits. It is repeated (when the vehicle speed is in the indicated ranges) only if the seat belt is fastened and unfastened again or, in any case, every time the engine is turned off and then on.

Warning



Each seat belt has been designed to protect only one occupant. If more than one person uses the same seat belt, the risk of injury in the event of an accident is increased.

The seat belt must never be passed around a baby, child or other person sitting on a passenger's lap.

Do not sit babies, small children or other persons on your lap.

If there is a collision, the weight of an adult may cause the child to be crushed by the seat belt causing severe or even fatal injuries.

Unfastening the seat belts

- Push the release button **E**.
- Guide the latch plate **A** back to its rest position.

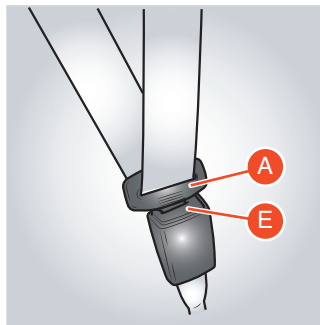

Use of the rear seat belts

(valid only in the presence of rear seats)

Warning



Only persons who are **less than 1.50 m tall** may travel in the rear seats.

The minimum distance between the head of the rear passenger when seated correctly and the rear screen must be at least 2.5 cm.

Persons on the rear seat who are taller risk serious injury in the event of an accident.

Persons on the rear seat who are taller risk serious injury if the retractable hard top is opened or closed.

Warning



The retractable hard top **MUST** only be operated when no persons and/or children are occupying the rear seats.

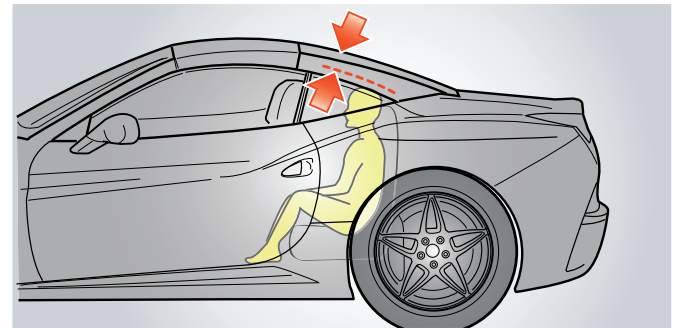

The rear seat belts must be fastened as shown in the diagram below

Warning



Remember that, in the event of a violent impact, passengers in the rear seats who are not wearing seat belts are not only subject to personal injuries (they can be catapulted forward, hit the windscreen and be thrown out of the vehicle) but also constitute a danger to the passengers in the front seats.

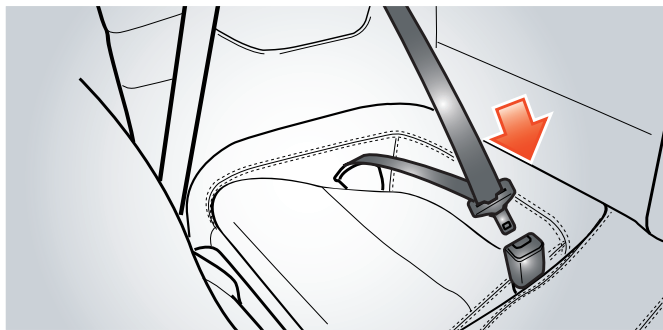

Pretensioners

The seat belts for the front seats are fitted with pyrotechnic-powered pretensioners. The pretensioner is activated by the airbag ECU in the event of a head-on collision (impact direction between 11 and 1 o'clock p.m.) of sufficient severity, or in a side collision of sufficient severity. The pretensioner is also activated when there is a sufficiently severe rear collision or a roll-over (see page 60). The belt will rewind a few centimetres just before the restraining action begins, thereby improving the fitting across the occupant's body.

Activation of a pretensioner is signalled by the illumination of the warning light **A** on the instrument panel.

Warning



Pretensioners that have been activated will no longer function and may not be repaired under any circumstances. Contact the **FERRARI SERVICE NETWORK** for replacement.

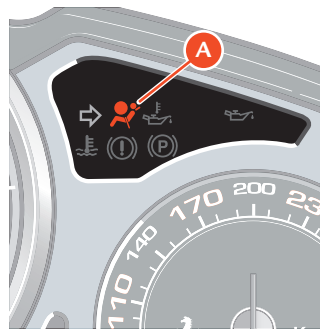

When a pretensioner is activated, a small amount of smoke is released. This smoke is not harmful.

Warning



Activation of the pretensioners only depends on the status of the seat belts and is not affected by the occupants' presence.

If the seat belt is not fastened, the pretensioner will not activate, even if the seat is occupied.

The seat belts for the front seats and any rear seats are fitted with a load limiting device. The load limiting device is located in the belt winder and allows controlled release of the belt during a collision thereby limiting the impact that the belt has on the occupant's body.

Maintenance of the seat belts and pretensioners

- Following a serious collision, replace the seat belts that were worn at the time even if they do not appear to be damaged.
- Periodically check that the screws on the anchoring points are tight and that the belt is in perfect condition and slides smoothly.
- The belt must be kept clean; the presence of any dirt could jeopardise the efficiency of the belt winder.
- To clean the seat belt, wash it by hand with mild soap and water and let it dry. Do not use strong detergents, bleach or aggressive solvents, as they can weaken the fibres.

Make sure the retractors do not get wet: proper functioning is ensured only if they are kept dry.

- The pretensioner requires no maintenance or lubrication.

If immersed in water or mud, it must be replaced.

- Pretensioners must be replaced at regular intervals as indicated in the “Warranty Booklet”.

Important note



All work on any part of this safety system must be performed by the FERRARI SERVICE NETWORK.

Warning



It is not permitted to remove or make modifications of any kind to the seat belts, belt retractors and pretensioners.

Maintenance work involving strong impacts, vibrations or heating of the pretensioner area may activate them; vibrations caused by road bumps will not have this effect.

Child safety

Warning



Never leave children **ALONE** and/or unattended in the vehicle since this may constitute a danger to themselves and others.

In a number of countries, the transportation in vehicles of children and infants is governed by specific legislation and traffic regulations.

Drivers are obliged to comply with applicable regulations.

Warning



This is an extreme sports vehicle. Do not use the vehicle to transport infants since sudden acceleration may cause injury.

Warning



Drive slowly and pay maximum care and attention when transporting children. Sudden acceleration caused by sports-style driving may be dangerous for children even if no collision occurs.

Warning



The instructions in this Owner's Manual **ONLY** apply to the **Standard** seat shown in the figure.

They do not apply to the **Optional** seat.

STANDARD



2-seater version

Warning



Do not transport young children in rear facing child restraint systems on the front passenger seat unless absolutely necessary.

Although the front passenger airbag has been designed and developed not to cause injury, it should be stressed that the muscle and bone structure of infants is not fully developed and therefore vulnerable; the risk of very severe or even fatal injury caused by activation of the airbag cannot therefore be excluded.

Warning



If you **absolutely have** to carry a child on the front passenger seat in a rear facing child restraint system, the front passenger seat must be positioned as far back as possible with the sides of the seat as far open as possible and the lumbar support adjustment as low as possible. The seat must also be adjusted to the lowest position to enable the child restraint system to be correctly installed.

Because of their size, children are at greater risk than adults. Suitable restraint or safety systems must be used.

All minors whose physical characteristics (i.e. height, weight) fall within the legal limits in force in each country must be protected by approved restraint or safety systems (e.g. child seats, cradles, cushions).

You are therefore advised to **ALWAYS** use homologated child restraint systems that bear the proper test marking and check they comply with the ECE-R 44 standard. Child seats homologated according to the ECE-R 44 standard bear the ECE-R 44 test marking (a circled E with the approval number underneath).

Warning



Incorrect fastening of a child restraint system increases the risk of injury to the child if an accident occurs.

- The seat belts in the vehicle have been designed and tested to protect persons weighing at least 36 Kg and taller than 1.50 m.
- To properly protect children outside these limits, specific restraint systems with dedicated belts or accessories capable of adapting the child's position to the vehicle seat belts must be fitted.

Warning



For installation and use (how to secure the child to the restraint system) of child restraint systems, follow the instructions that the manufacturer of the devices is obliged to provide.

Warning



Carefully follow the instructions provided with the child seat: keep them in the vehicle together with the documents and this manual. Do not use second-hand child seats with no instructions.

Warning



Follow the instructions given by the child restraint system manufacturer when choosing, installing and using the restraint system since failure to do so may compromise its protective action.

Warning



Always check the seat belt have been securely fastened by pulling on the seat belt.

Warning



After an accident, have all the parts of the child restraint system and vehicle seat belt system checked and replace them if necessary.

Any work must be performed at the FERRARI SERVICE NETWORK.

Children must always be transported in restraint systems that are suitable for their size.

Before choosing a child restraint system, always check that:

- it is homologated. Child seats homologated according to the ECE-R 44 standard bear the ECE-R 44 test marking (a circled E with the approval number underneath)
- it is suitable for the height and weight of the child to be transported (CAREFULLY FOLLOW the instructions in the child restraint system use and maintenance manual)
- it can be securely installed in the vehicle in compliance with the child restraint system manufacturer's instructions
- the use and installation instructions are easy to understand.

Warning



If violent braking or a collision occurs, children who are not in a restraint system can be thrown against the dashboard or the windscreen: this may lead to serious or even fatal injury to the child.

Warning



Never allow children to travel sitting in the lap of an adult. If there is a collision, the adult's weight may crush the child against the seat belt or the dashboard: this may lead to serious or even fatal injury to the child.

Important note



NO modifications must be made to the seat belts and child restraint systems: any modifications may seriously jeopardise the safety of the child restraint system.

The front passenger seat does not have special hooks for child restraint systems.

To transport a child, use the seat belts to secure the child restraint system to the vehicle seat and make sure you have activated the automatic belt winding locking system before installing the child seat in the vehicle.

To activate the automatic belt winding locking system, pull the seat belt until the belt completely unwinds. At this point, the belt retractor will only allow the seat belt to rewind.

The fact that the belt cannot be pulled out confirms that the belt locking system has been activated.

To deactivate the locking system, unfasten the seat belt in order to allow it to rewind completely.

Warning



Each time the belt is used to fasten a normal occupant, the automatic belt winding locking system will have to be deactivated.

Warning



In countries where it is already a legal requirement, children under 12 years of age may not travel in the front passenger seat. **ALWAYS COMPLY** with the legal requirements in force in your own country.

Important note



For child restraint systems that can be installed on the 2-seater version with 3-point seat belts, see **TAB 1**, pages 98-99.

2 + 2-seater version

Warning



Do not transport young children in rear facing child restraint systems on the front passenger seat unless absolutely necessary.

Although the front passenger airbag has been designed and developed not to cause injury, it should be stressed that the muscle and bone structure of infants is not fully developed and therefore vulnerable; the risk of very severe or even fatal injury caused by activation of the airbag cannot therefore be excluded.

Warning



If you **absolutely have** to carry a child on the front passenger seat in a rear facing child restraint system, the front passenger seat must be positioned as far back as possible with the sides of the seat as far open as possible and the lumbar support adjustment as low as possible. The seat must also be adjusted to the lowest position to enable the child restraint system to be correctly installed.

Because of their size, children are at greater risk than adults. Suitable restraint or safety systems must be used.

All minors whose physical characteristics (i.e. height, weight) fall within the legal limits in force in each country must be protected by approved restraint or safety systems (e.g. child seats, cradles, cushions).

You are therefore advised to **ALWAYS** use homologated child restraint systems that bear the proper test marking and check they comply with the ECE-R 44 standard. Child seats homologated according to the ECE-R 44 standard bear the ECE-R 44 test marking (a circled E with the approval number underneath).

Warning



Incorrect fastening of a child restraint system increases the risk of injury to the child if an accident occurs.

- The seat belts in the vehicle have been designed and tested to protect persons weighing at least 36 Kg and taller than 1.50 m.
- To properly protect children outside these limits, specific restraint systems with dedicated belts or accessories capable of adapting the child's position to the vehicle seat belts must be fitted.

Warning



For installation and use (how to secure the child to the restraint system) of child restraint systems, follow the instructions that the manufacturer of the devices is obliged to provide.

Warning



Carefully follow the instructions provided with the child seat: keep them in the vehicle together with the documents and this manual. Do not use second-hand child seats with no instructions.

Warning



Follow the instructions given by the child restraint system manufacturer when choosing, installing and using the restraint system since failure to do so may compromise its protective action.

Warning



Always check the seat belt have been securely fastened by pulling on the seat belt.

Warning



After an accident, have all the parts of the child restraint system and vehicle seat belt system checked and replace them if necessary.

Any work must be performed at the **FERRARI SERVICE NETWORK**.

Children must always be transported in restraint systems that are suitable for their size.

Before choosing a child restraint system, always check that:

- it is homologated. Child seats homologated according to the ECE-R 44 standard bear the ECE-R 44 test marking (a circled E with the approval number underneath)
- it is suitable for the height and weight of the child to be transported (**CAREFULLY FOLLOW** the instructions in the child restraint system use and maintenance manual)

- it can be securely installed in the vehicle in compliance with the child restraint system manufacturer's instructions
- the use and installation instructions are easy to understand.

Important note



NO modifications must be made to the seat belts and child restraint systems: any modifications may seriously jeopardise the safety of the child restraint system.

Warning



In countries where it is already a legal requirement, children under 12 years of age may not travel in the front passenger seat. ALWAYS COMPLY with the legal requirements in force in your own country.

Warning



The retractable hard top MUST only be operated when no persons and/or children are occupying the rear seats.

Warning



Before operating the retractable hard top, make sure that the backrest of the child restraint system is set to its minimum height.

The rear seats of the vehicle have an ISOFIX lower anchorage system (2 for each rear seat) (marked **A** in the diagram) that is placed under the special leather cover.

The vehicle has no upper anchorage systems.

Warning



Before installing a child restraint system on the rear seats, the corresponding front seat must first be positioned as far forward as possible with the backrest as upright as possible.

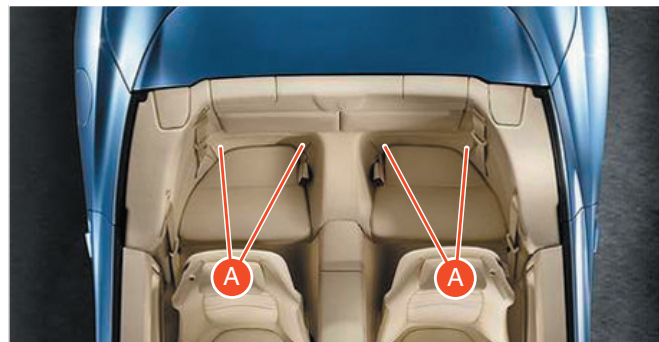

Warning



If violent braking or a collision occurs, children who are not placed in a restraint system can be thrown against the dashboard, windscreen or front seats: this may lead to serious or even fatal injury to the child.

Warning



Never allow children to travel sitting in the lap of an adult. If there is a collision, the adult's weight may crush the child against the seat belt, the dashboard or the back of the front seat: this may lead to serious or even fatal injury to the child.

Important note



For child restraint systems that can be installed on the 2 + 2-seater version with 3-point seat belts and ISOFIX, see **TAB 2.** and **TAB. 3.** on pages 98-99.

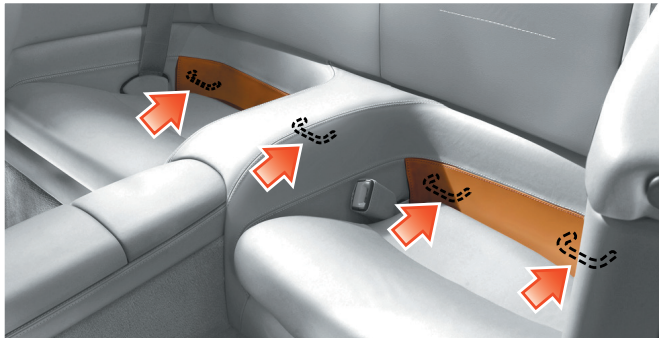

Auxiliary Occupant Protection Systems

Warning



The Auxiliary Occupant Protection Systems are not a substitute for the seat belts but increase their efficiency. Correct use of the seat belts with the supplementary action of the Auxiliary Occupant Protection Systems, offers maximum protection in the event of a head-on collision or vehicle roll-over.

Auxiliary Occupant Protection System components

The Auxiliary Occupant Protection System components are:

1. Seat with built-in headrest and belt loop.
2. Dual-stage front driver airbag.
3. Dual-stage front passenger airbag.
4. Driver side head protection side airbag (head bag).
5. Passenger side head protection side airbag (head bag).

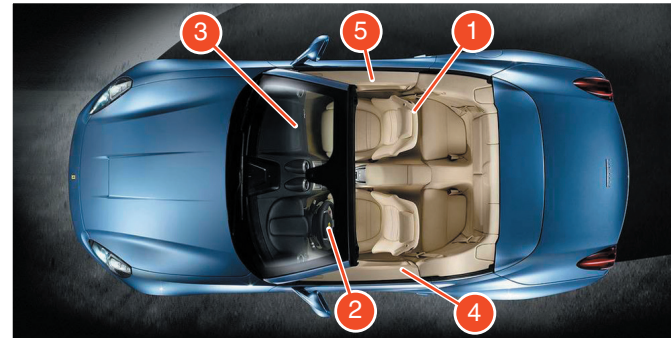

6. Driver's seat belt (3-point with pretensioner and an automatic system that reduces the force applied to the occupant).
7. Front passenger seat belt (3-point with pretensioner and an automatic system that reduces the force applied to the occupant).
8. Rear seat passenger seat belt (3-point with automatic system that reduces the force applied to the occupant).
9. Rear seat passenger seat belt (3-point with automatic system that reduces the force applied to the occupant).
10. Active roll bars
11. Electronic Control Unit (ECU).
12. Additional sensors.
13. Instrument panel warning light.
14. Deformable body.

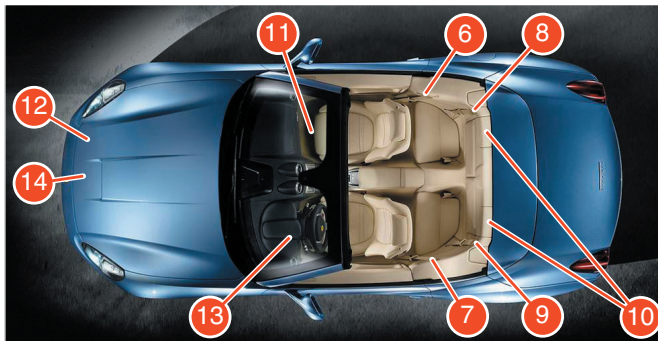

The airbags **1** and **2** have been designed to increase the level of protection given by the seat belts in the event of a head-on collision (see page 60).

The airbags **3** and **4** have been designed to increase the level of protection given by the seat belts in the event of a side-on collision and are placed between the occupant's head and external structures which could go through the passenger compartment and cause injury (see page 78).

The roll bars **10** have been designed to help maintain a survival area in the event of a roll-over (see pages 81-83).

Since it is impossible to gauge vehicle dynamics and movements of the occupants in an accident, the active roll bars are also activated as a precautionary measure in the event of:

- sufficiently severe head-on collisions (that activate the front airbags) if they have caused a cut-out of the fuel supply
- sufficiently severe side-on or rear collisions.

Warning



The warning light **A** comes on when the ignition key is turned to position II. If no malfunctions are detected, it goes out after approximately 4 seconds. If the warning light does not come on, if it remains on or if it comes on while driving, contact the **FERRARI SERVICE NETWORK** immediately.

Driver and passenger airbags

Warning



The front airbags do not offer protection in the event of side-on collisions, some head-on/angular collisions, roll-overs or subsequent collisions (if there is a second collision once the airbags have been deployed in an earlier collision). The seat belts have been designed to reduce the risk of injury in the event of a roll-over or subsequent collision.

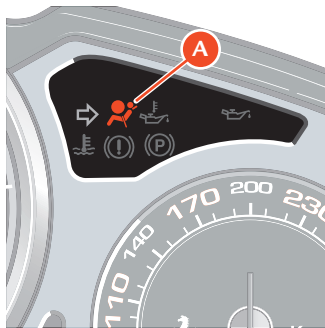

Warning



The front airbags have been designed not to inflate if a minor collision occurs. The seat belts have been designed to reduce the risk of injury if a minor collision occurs.

Warning



The driver and the passenger must maintain a distance of at least 25 cm from the steering wheel and the dashboard.

Always drive with your hands on the rim of the steering wheel so that in the event of activation, the airbag can deploy without obstruction.

Driving with your hands on the steering wheel spokes or on the airbag cover increases the risk of injury for your wrists and arms.

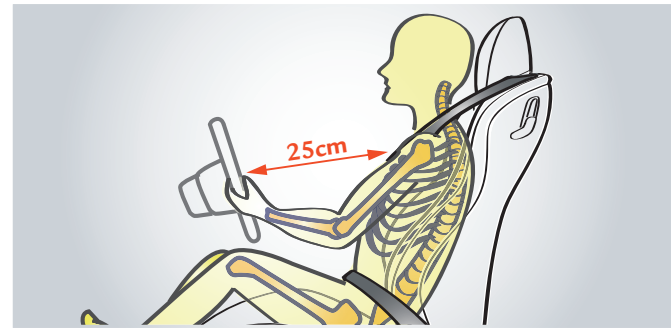

Warning



The front passenger must be seated correctly: never put hands, feet or legs on the dashboard since if the front airbag is activated, it may cause injury to the legs and prevent the airbag from working properly.

Operation

The front airbags are controlled by an ECU which activates them in the event of a head-on collision (direction of impact between 11 and 1 o'clock p.m.) of sufficient severity.

In the case of a collision with an impact force that causes deceleration exceeding the value set for the internal sensor, the ECU will transmit a signal to deploy the airbags. The airbags will begin to inflate, breaking the cover along the breakage line and will deploy completely in a few tenths of milliseconds. Once deployed, they will serve as protection between the driver and/or passenger and structures that could cause injury.

The airbags deflate immediately afterwards.

Important note



If a head-on collision occurs that causes a cut-out of the fuel supply, the active roll bars will also be activated as a precautionary measure.

Warning



The driver and passenger should not carry objects (drink cans or bottles, pipes, etc.) that may cause injury if the airbags are activated. Persons, animals or items must not be placed between the airbags and the occupant.

Environment



When the system is activated, gases are released in the form of fumes, together with the gas used for inflating the airbags. These gases are not harmful.

The driver's airbag has been designed to be deployed according to the following strategy:

- For low severity crashes, the airbag control unit will not deploy the airbag.
- For crashes of higher severity, the control unit will deploy the driver airbag in low energy mode.
- For crashes of even higher severity, the control unit will deploy the driver airbag in high energy mode.

The passenger airbag has been designed to be deployed according to the following strategy:

- For low severity crashes, the airbag control unit will not deploy the airbag.
- For crashes of higher severity, the control unit will deploy the passenger airbag in low energy mode.
- For crashes of even higher severity, the control unit will deploy the passenger airbag in high energy mode.

Warning



Even in vehicles with Advanced Airbag Systems, according to statistics, the rear seats are the safest for transporting babies and small children.

Children must always be transported on the rear seats if the vehicle has them.

Warning



The driver and passenger must always fasten their seat belts and sit in an upright position, as far as possible away from the airbag, in order to have optimal protection in all types of collision.

Warning



Always keep the backrest of your seat in the upright position and sit with your back properly resting against it.

Important note



Do not modify the system components or wiring, under any circumstances.

With the ignition key inserted and in position **II**, although the engine is off, the airbags can still be activated when the vehicle is



stationary if it is hit by a moving vehicle.

Remember that if the ignition key is set to 0 none of the safety devices (airbags or pretensioners) is activated in the event of a collision; failure of the airbags to inflate in these circumstances is not indicative of a system malfunction.

Important note



Do not cut or tamper with the connectors of the airbag harness or on the airbag modules.

Warning



Do not cover the steering wheel and the padded panel on the dashboard on the passenger's side with adhesive tape or treat it in any way.

Warning



Do not place objects above or near the top of the dashboard and the steering wheel.

In the event that the airbags are deployed, these objects would be propelled into the passenger compartment at a high speed that would seriously jeopardise the safety of the occupants.

Warning



The airbag modules are subject to wear and tear and must be replaced at the intervals indicated in the "Warranty Booklet" even if the vehicle has NOT been involved in a collision.

Warning



Do not modify the airbag modules in any way (indicated in the relevant diagram). Do not damage the airbag modules (for example pinning something onto them or pressing objects against their covers).

If, for any reason, an airbag cover gets damaged, have the airbag module immediately checked by the FERRARI SERVICE NETWORK.

Activation of a damaged module could cause serious or fatal injuries.

Important note



Do not remove or dismantle parts of the steering wheel, dashboard or door panels; If necessary, this procedure should only be performed by a FERRARI SERVICE NETWORK CENTRE.

Important note



All the airbag system components must be replaced after an accident that caused airbag deployment.

Important note



Following an accident not involving airbag deployment, contact the FERRARI SERVICE NETWORK to have the system checked and any system components that may be damaged or malfunctioning replaced.

Important note



The airbag system components have been specially designed only for this specific vehicle model. Do not use them on a different vehicle model, as this may cause serious damage and consequent injury, even fatal, to the occupants in the event of an accident.

Warning



Damaged or defective components of the airbag system cannot be repaired and must be replaced.

Improper operations performed on the system components may cause failures or accidental deployment or failure of the airbags to inflate with consequent damage and injury, even fatal.

Environment



To scrap the vehicle, please contact the FERRARI SERVICE NETWORK to have the airbag system deactivated.

Important note



If the vehicle has been stolen or there has been an attempted theft, have the airbag system checked by the FERRARI SERVICE NETWORK.

Important note



The label **E** on the right-hand side of the dashboard, bears the airbag system expiry date. When this expiry date is approaching, contact the FERRARI SERVICE NETWORK in order to have the system replaced.

The label **F** indicates the presence of the airbag system.



Head Airbags

Warning



The airbags are not a substitute for the seat belts although they increase their efficiency. Correct use of the seat belts, with the supplementary action of the head bags, offers maximum protection in the event of a collision or vehicle roll-over.

Head bag system components

Warning



The head bag fitted on the vehicle was not designed to reduce the risk of being hurled out in the event of vehicle roll-overs.

The vehicle has 2 head bags, one in the driver-side door and the other in the passenger-side door.



The head bag system consists of 2 airbags, one on each door. In the event of a side-on collision, the airbag on the impact side deploys immediately to protect the occupants' head.

Warning



When the ignition key is turned to position **II**, the warning light **B** will come on. If no malfunctioning in the airbag system is detected, it will go off after 4 seconds. If the warning light does not come on, if it remains on or if it comes on while driving, **CONTACT the FERRARI SERVICE NETWORK immediately.**

Operation

The head bags are controlled by the ECU that activates them when a sufficiently severe collision occurs.

In the event of a side collision with a force of impact exceeding the limit set by the ECU, this will transmit a signal that activates the pretensioner, the head bag on the impact side and the active

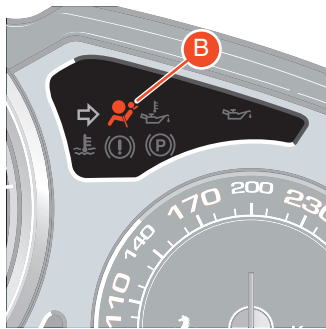

roll bars (precautionary measure because of possible deformation of the vehicle body that may affect deployment if there is a subsequent roll-over.

The airbag will start inflating, opening its cover along the breaking line, until it is fully deployed (in a few hundredths of seconds). After deployment, the head bag will act as a protection between the driver's or passenger's head and the external structures which could go through the passenger compartment and cause injury. The airbags deflate immediately afterwards.

Head bag activation is not affected by the front passenger's height or weight. The side bag is activated whenever the airbag ECU detects a collision of a sufficient impact force for deployment.

Warning



Never drive with your head out of the window as this places your head and neck in the airbag deployment area. In the event of a side-on collision, this position increases the risk of being thrown out of the vehicle and compromises the protective action of the head bags.

Warning



Never place an object over or near the airbag covers. In the event that the airbags are deployed, these objects would be propelled into the passenger compartment at such high speed as to seriously jeopardise the safety of the occupants.

Warning



Never modify the airbag modules. Do not damage the airbag modules and trim panels above them (for example, the area above the door panel) (by pinning something onto them or pressing objects against their covers, for example).

If, for any reason, an airbag cover gets damaged, have the airbag module immediately checked by the FERRARI SERVICE NETWORK. Activation of a damaged module could cause serious injuries.

Important note



Please consider that the airbag ECU is not capable of automatically detecting damages involving the airbag covers.

Do not cover the upper part of the driver-door and passenger-door panels with adhesive tape or material and do not treat them in any way.

Warning



After deployment, the airbag components can no longer offer any protection; therefore, they cannot be repaired and must be replaced. After activation of a head bag, have it replaced by the FERRARI SERVICE NETWORK.

Warning



The airbag modules are subject to wear and tear and must be replaced at the intervals indicated in the “Warranty Booklet” even if the vehicle has NOT been involved in a collision.

Important note



The label **E** on the right-hand side of the dashboard, bears the airbag system expiry date. When this expiry date is approaching, contact the FERRARI SERVICE NETWORK in order to have the system replaced.

Important note



Never remove the door panel. If required, this operation must be performed by the FERRARI SERVICE NETWORK.



Roll bar

The active (ejectable dynamic) roll bar has been designed and installed to maintain the survival area of occupants in the event of a vehicle roll-over.

The active roll bars are controlled by the ECU that activates them when there is a strong roll around the longitudinal axis of the vehicle and there is a risk that the vehicle will roll over.

In the case of a roll that exceeds the calibration thresholds, the ECU will release the roll bar locking system and deploy the roll bars in a few tenths of a second. Once deployed, the active roll bars help to maintain an occupant survival area together with the windscreen surround (and the hard top if used).

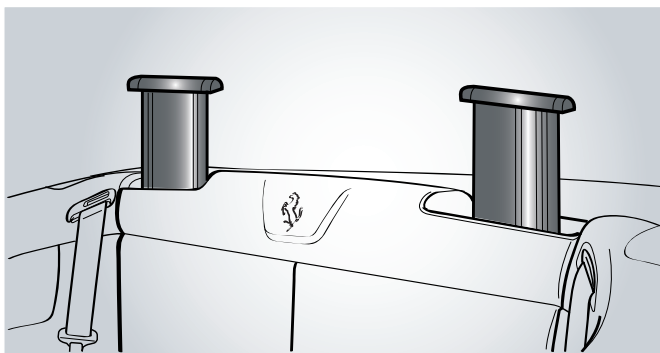

Warning



The active roll bars do not reduce the risk of ejection of occupants who are not wearing seat belts or the risk of injury caused by impact with the interior of the vehicle in the event of a collision or roll-over.

Seat belts must always be fastened to reduce the risk of being thrown out of the vehicle and reduce the risk of injury caused by impact with the interior of the vehicle.

Important note



The active roll bars are also deployed in the event of a sufficiently severe rear or side collision as a precautionary measure against subsequent roll-over of the vehicle.

Since it is impossible to gauge vehicle dynamics and movements of the occupants in an accident, the active roll bars are also activated as a precautionary measure in the event of:

- sufficiently severe head-on collisions (that activate the front airbags) if they have caused a cut-out of the fuel supply
- sufficiently severe side-on or rear collisions.

Important note



The active roll bars are not deployed in the event of a roll-over around a transverse axis (**Y** axis in the figure).

Warning



Do not travel with rear occupants resting their heads on the roll bar covers, facing the back of the vehicle or seated on top of the roll bar covers.

If activated, the roll bars will increase the risk of injury.

Warning



Never place objects over or near the roll bar covers.

If the roll bar is activated, they may delay or prevent it coming out.

They could also be propelled into the passenger compartment at such high speed as to seriously jeopardise the safety of the occupants.

Warning



If activated, the roll bar must be replaced.

Contact the **FERRARI SERVICE NETWORK**.

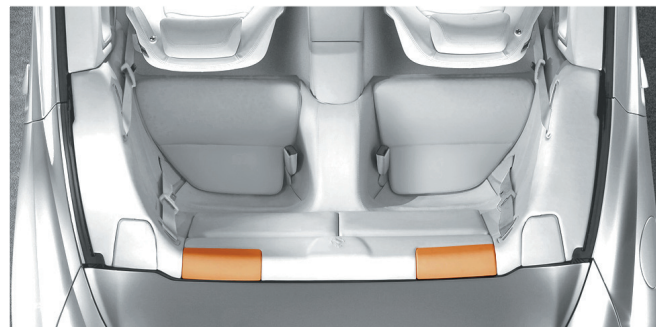

Warning



The roll bar is a pyrotechnic-powered system.
System cannot be repaired.
Risk of injury if accidentally activated
Each operation must only be performed by authorised staff.
Contact the FERRARI SERVICE NETWORK.

Warning



Never modify the roll bar modules. Do not damage the roll bar module covers (for example pinning something onto them or pressing objects against their covers).
If, for any reason, a roll bar cover gets damaged, have the roll bar module immediately checked by the FERRARI SERVICE NETWORK.
Activation of a damaged roll bar module could cause serious or fatal injuries.

Warning



The roll bar modules are subject to wear and tear and must be replaced at the intervals indicated in the “Warranty Booklet” even if the vehicle has NOT been involved in a collision.

Fuel inertia switch

This is a safety switch **A** in the passenger compartment on the floor in front of the driver seat that deactivates the petrol pump relays if a collision occurs.

A symbol on the TFT display and the hazard warning lights light up to indicate that the switch has been activated.

When activated, the doors are also unlocked (if locked) and the central dome light comes on.

Warning



The system can be reactivated by pressing the button on the top of the switch.

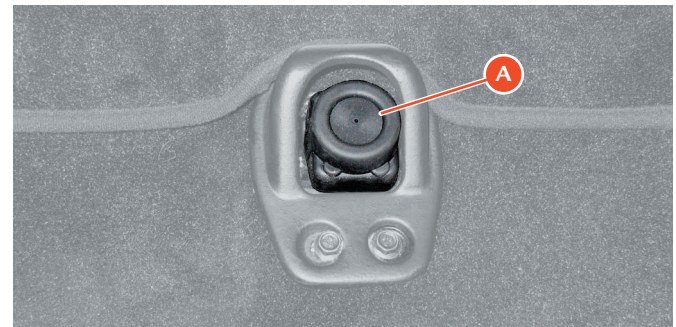

ABS

This is a safety device which activates to prevent wheel locking if the driver depresses the brake pedal too sharply, especially under poor grip conditions.

The system is composed of:

- electro-hydraulic unit
- electronic brake-force distribution **EBD**
- four speed sensors on the wheels, incorporated in the bearings.
- the entire ESP sensor system (steering angle sensor, accelerometer, yaw sensor, etc.).

These features add to the vehicle's standard braking system, without changing its characteristics.

Important note



When the **ABS** system is active, during emergency braking or in poor grip conditions, a “pulsing” sensation will be felt through the brake pedal. Hold the brake pedal down to continue the braking action.

When one of the wheels starts locking, the hydraulic control unit controls the braking circuit by running a 3-phase cycle:

- reduction (if necessary)
- maintenance
- pressure increase in the hydraulic circuit.

These adjustment phases will be repeated in cycles in the event that brakes are applied with **ABS** intervention, until the vehicle comes to a stop or the pressure on the pedal decreases.

In addition, the system offers the following advantages:

- Driving stability (no skidding): even in the event of sharp braking approaching wheel locking.
- Manoeuvrability (no side-skidding on sharp turns).

This means that even when an emergency situation requires sudden braking, the driver can avoid obstacles, or brake on a curve, without affecting the vehicle stability.

Warning



The **ABS** system features remain unaltered as long as the speed limit for the tyre side grip is not exceeded. When this limit is exceeded, vehicle skidding cannot be avoided.

- Optimal braking distance :
depending on the type of road surface, the braking distance may be reduced by as much as 40%.

Warning



The **ABS** system does **NOT** exempt the driver from driving carefully and responsibly at all times.

Important note



The **ABS** system cannot compensate for driving at excessive speeds with respect to the traffic or road conditions, worn tyres, worn braking system components or driver errors.

The **ABS** system has been designed for the sole purpose of assisting the driver in controlling braking under extreme conditions, in which he/she could instinctively cause the wheels to lock.

CST - Stability and Traction Control

The CST is composed of two main systems:

VDC Vehicle Dynamics Control, performed through the braking system and engine torque

F1-Trac traction control, performed through engine torque modulation, depending on maximum grip on the road and of secondary systems that are always active, such as the **ABS**, **EBD**, etc.

To provide optimal control in different driving and grip conditions, four different setting levels have been designed:

- **Level 1:** ensures stability and maximises traction on every type of road surface, both in low (Manettino set to **Comfort**) and very low grip conditions, by means of engine and brake control (in this condition, the standard **ASR** system activates instead of the **F1-Trac** function).
- **Level 2:** ensures stability and maximises traction only in medium- to high-grip conditions (Manettino set to **SPORT**) optimising engine and brake control.
- **Level 3:** CST off (position **CST**). Stability is not ensured, but all the other features always present in the other settings, such as the **ABS** and **EBD**, remain active. When the brake pedal is depressed, the **VDC** system reactivates.

F1-Trac

F1-Trac is directly derived from Ferrari's expertise in F1 vehicles. This system optimises traction by controlling engine power delivery.

F1-Trac is faster and more accurate than the traditional control systems, and is capable of delaying and minimising engine torque adjustments as required, in order to ensure the desired trajectory.

The system estimates the maximum available grip in advance, by continuously monitoring the relative wheel speed and using an auto-adaptive operation logic. Comparing this information with the vehicle dynamics model stored in the control system, **F1-Trac** optimises the vehicle behaviour by controlling engine torque delivery.

Important note



F1-Trac does not work when the Manettino is set to CST off.

EPB - Electronic parking brake

The parking brake is controlled by a small electric engine.

It can be applied and released using the special control **A** on the dashboard to the left of the steering wheel.

The brake is automatically activated when the engine is switched off and can be temporarily deactivated by pressing the **AUTOPARK B** button.

Pushing down the brake pedal and pressing button **A** deactivates it automatically.

The electric parking brake can operate as an emergency brake when the vehicle is in motion.

If this is the case, the electric parking brake communicates with the ESP system to prevent locking. The warning light will turn off when the parking brake is fully released.

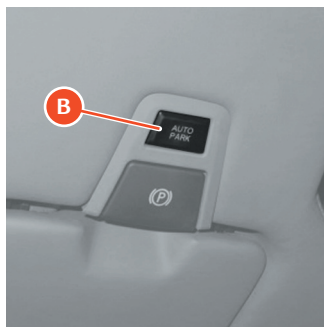
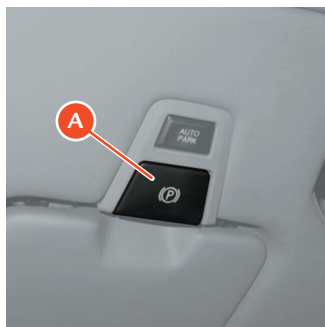

Its characteristics are:

- Gradual release of brake shoes/pads when vehicle starts up (**AVH** function): this guarantees an optimised release
- Automatic activation when engine is switched off (**AUTOHOLD** function) with possibility of disabling automatic activation using the **AUTOPARK B** button which is part of the EPB control.

Warning



Always apply the parking brake when the vehicle is parked.

The vehicle should be blocked. If this is not the case, please contact the **FERRARI SERVICE NETWORK**.

TFT display warning light display priority levels

Priority level 0 (Extremely critical malfunction): is displayed for 20 seconds.

Priority level 1/Priority level 2 (Critical malfunction/Non-critical malfunction): is displayed for 20 seconds in the centre of the TFT display. After 20 seconds, the symbol remains displayed in minimised form if there is no specific warning light.

Tyre pressure and temperature monitoring system

The vehicle is equipped with a system that measures tyre pressure and temperature using special sensors fixed inside the wheel rims next to the air valve. These sensors send a signal that is received by the antennas fixed to the body behind the gravel guards that are connected to the ECU.

Important note



The system may be momentarily affected by radioelectrical interference from devices that use similar wavelengths.

The ECU processes this information and transmits data on tyre pressure and temperature and any system errors to the instrument panel via a CAN line.

The signal transmitted by the ECU activates symbols on the TFT display with two priority levels: a **soft warning** (sw) if the pressure loss compared with the nominal pressure **exceeds 0.2 bar** and a **hard warning** (hw) if it **exceeds 0.5 bar** or there is a dynamic loss of over 0.2 bar/min.

The system can be calibrated using the special menu item in the TFT display (see page 123).

Important note



System calibration using the special menu item on the TFT display is necessary after replacement or inflation of a tyre or tyres.

Warning



The system warns the driver that there is a drop in tyre pressure. However, this does not exempt the driver from periodically checking that the tyres are inflated to the indicated pressure. In addition, the system does NOT warn the driver of damage to the tyres by external agents.

Displaying messages on the “TFT” display

By pressing a special **DISP** button, the driver can access the **TYRES** screen page that shows the pressure and temperature values of each tyre as in the following example **1**.

The **TYRES** screen page can be set as the standard screen page (see page 127).

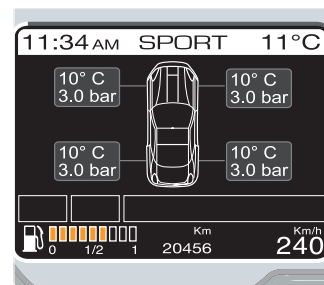

If an event occurs that needs to be viewed when the **TYRES** screen page is being displayed, the screen is displayed in reduced form as in the following example **1**:

Once it has been displayed, the **TYRES** screen page is displayed again. If malfunctions/events occur for which a summary symbol needs to be displayed, the symbol will be displayed in one of the two specific areas (example **2**) until the malfunction is corrected.

Low pressure

When the on-board instrument panel receives the signal from the tyre pressure ECU that the pressure level of one or more tyres is below the *alarm threshold*, the following screen will appear (with any type of screen displayed):

- for a warning for only one tyre (example **3**)
- for a warning for several tyres (example **4**).

Once the display time has elapsed, the screen page disappears.

The next time the engine is started, if the failure persists, the screen page shown above will be displayed (example **3** or **4**).

The **TYRES** screen page can be displayed by pressing the special **DISP** button. In this way, you can locate the tyres with insufficient pressure compared with normal operating conditions at any time (example **5**).

Occasionally, the system may be unaware of which wheel signals a failure and cannot therefore specify the right wheel.

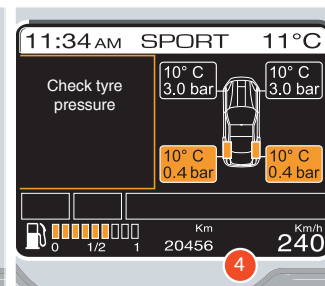
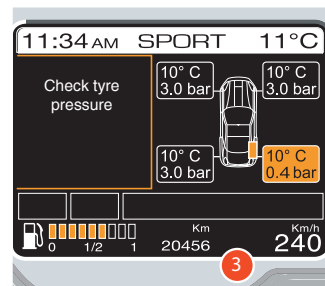
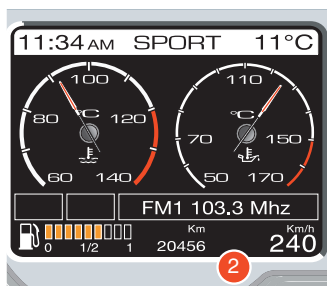
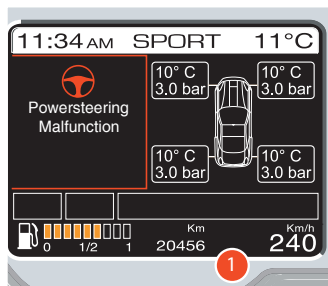

If this occurs, the following screen page will be displayed (example 6).

Once the display time has elapsed, the screen page disappears.

The **TYRES** screen page showing the pressure of each tyre cannot be recalled by the driver.

Obviously, the next time the engine is started, if the pressure fault persists, the screen page will be displayed again and once the display time has elapsed, the screen page disappears.

Tyre puncture

When the on-board instrument panel receives the signal from the tyre pressure ECU that the pressure level of one or more tyres is below the alarm threshold, the following screen will appear (with any type of screen displayed):

- for vehicles with normal tyres (example 7)
- for vehicles with RUN FLAT tyres (example 8)

At the same time, the relative warning light on the instrument panel turns on (see page 142).

If normal tyres are used, the failure follows the same display logic as the other failures with **priority 0** until the situation is corrected and the system requires subsequent calibration.

When the display cycle ends, the screen page disappears whereas the warning light remains on in fixed mode.

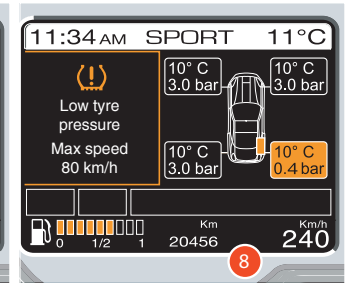
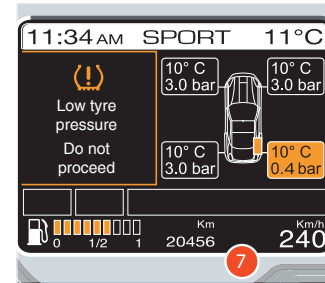
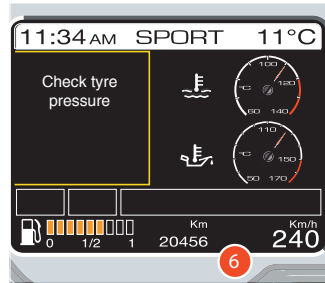
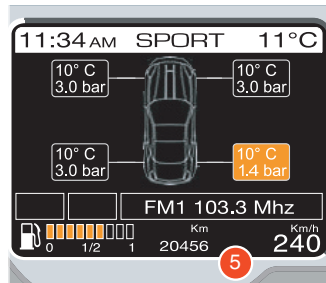

When the **TYRES** screen page is displayed, you can identify the punctured tyre under normal operating conditions (example 9).

The instrument panel will calculate the residual tyre life and repeat the display after 50 km (31 mi).

During the “punctured tyre” condition, after driving more than 100 km (62 mi), the screen page (example 10) will be displayed or if the vehicle speed exceeds 80 km/h (50 mph), the screen page (example 11) will be displayed according to the logic for **priority level 0** faults.

If another tyre is punctured, the instrument panel will calculate the updated number of km (mi) which can still be driven based on the distance driven after the previous puncture (example 12).

If the driver presses the **MODE** button while the **priority 0** (normal tyre puncture) or **priority 2** (Run Flat tyre puncture not in a speed limit exceed condition with the tyres still in a driving condition) faults are being displayed, the screen page will disappear but the warning light will remain on in fixed mode.

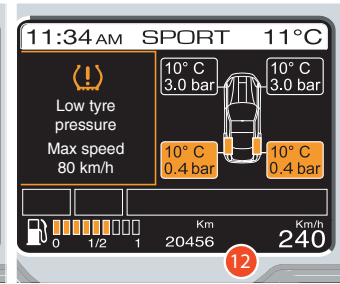
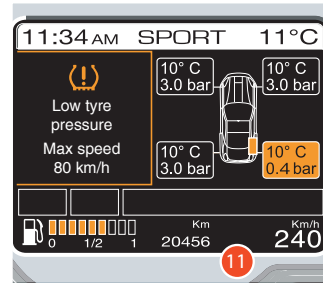
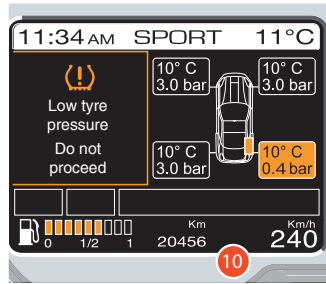
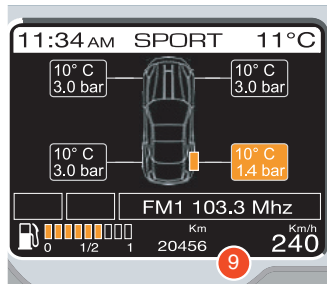

Here too, the **TYRES** screen page can be displayed by pressing the special **DISP** button. In this way, you can locate the punctured tyres compared with normal operating conditions at any time (example **13**).

Occasionally, the system may be unaware of which wheel signals a failure and cannot therefore specify the right wheel. In this case, the following screen page will be displayed:

- for vehicles with normal tyres (example **14**). If the fault occurs when the **TYRES** screen page is displayed, the displayed screen page will automatically become the default one.

- for vehicles with RUN FLAT tyres (example **15**). If the fault occurs when the **TYRES** screen page is displayed, the displayed screen page will automatically become the default one.

When the display cycle ends, the screen page disappears whereas the warning light remains on in fixed mode.

The instrument panel will calculate the residual tyre life and repeat the display after 50 km (31 mi).

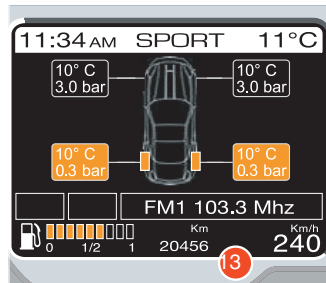

During the “punctured tyre” condition, after driving more than 100 km (62 mi), the screen page (example 16) will be displayed or if the vehicle speed exceeds 80 km/h (50 mph), the screen page (example 17) will be displayed according to the logic for **priority level 0** faults.

The **TYRES** screen page showing the pressure of each tyre cannot be recalled by the driver.

System not calibrated

Warning



Before calibrating the system, make sure that the tyre pressure corresponds to the indicated pressure values (see page 28). If this is not the case, the system may issue wrong low pressure indications.

If the system has not been calibrated or after replacement of one or more tyres, the screen page (example 18) will be displayed.

At the same time, the warning light on the instrument panel (see page 142) will flash for 90 sec.

When the display cycle ends, the screen page disappears. The warning light remains on until the system has been calibrated.

The system can be calibrated using the special menu item in the TFT display (see page 123) (ignition key in position **II** and engine off).



16



17



18

When the Menu item is displayed and the subsequent calibration accepted, the following screen page (example 19) appears for 5 sec. If the **TYRES** screen page is displayed, the displayed screen page will automatically become the default one (example 20).

For “Calibration Activated” the **TYRES** screen page can be called up but the pressure and temperature values are replaced by dashes.

Tyre pressure monitoring system failure

The following screen page (example 21) is displayed in the following cases:

- fault on the circuit and/or wiring to the ECU
- signal is not received by one or more sensors due to a faulty, broken or flat battery
- fault in the TPMS ECU.

At the same time, the warning light on the instrument panel (see page 142) will flash for 90 sec. The warning light then remains on in flashing mode until the situation is corrected.

If the **TYRES** screen page is displayed, the displayed screen page will automatically become the default one (example 21).

The **TYRES** screen page cannot be recalled by the driver.

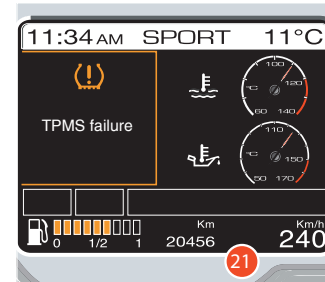

System temporarily inactive

When the following conditions occur:

- temperature too high
 - during calibration (the TPMS ECU does not recognise the sensors)
 - radio frequency that interferes with the wheel sensor signal
- the following screen page appears (example 22).

At the same time, the warning light on the instrument panel (see page 142) will flash for 90 sec. The warning light then remains on in flashing mode until the situation is corrected.

Subsequently (or after pressing the special **DISP** button), the screen page disappears whereas the warning light remains on.

The **TYRES** screen page cannot be recalled by the driver.

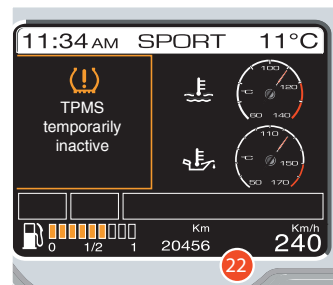

System inactive

For a few seconds at key-on, if the system has been deactivated by a diagnosis tool, the following screen page appears (example 23).

At the same time, the warning light on the instrument panel (see page 142) will flash for 90 sec. The warning light then remains on in flashing mode until the situation is corrected.

If the **TYRES** screen page is displayed, the displayed screen page will automatically become the default one.

Subsequently (or after pressing the special **DISP** button), the screen page disappears whereas the warning light remains on.

The **TYRES** screen page cannot be recalled by the driver.

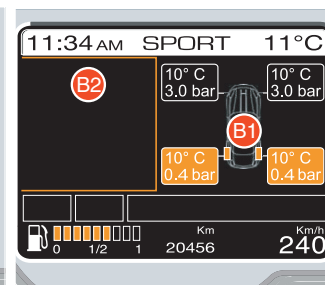
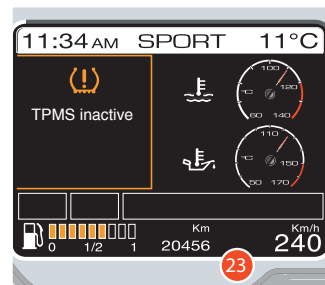

Summary of TPMS displays

| Function | Message + Symbol (Area B2) | Vehicle Symbol (Area B1) | Recovery (no connection) | TYRES screen page can be displayed on request | |
|--|---|---|---|--|-----------------------------|
| | | | | In normal conditions | Recovery (no connection) |
| Low tyre pressure | Check tyre pressure | Vehicle with tyre pressure and temperature values. The background of the box indicating the pressure value for the faulty tyre is amber. | Generic failure symbol + specific symbol + “Electrical system failure” message for 20 sec. | Vehicle symbol in the centre of the TFT display with tyre pressure and temperature values. The background of the box with the pressure value for the faulty tyre is amber. | Not recallable |
| Low tyre pressure (when the system does not recognise the tyre) | Check tyre pressure (message only) | - | After 20 sec. or when the MODE button is pressed, the generic failure symbol is minimised | Not recallable | |
| TPMS not calibrated | TPMS not calibrated Execute calibration + Tyre (amber) | - | | Not recallable | |

Summary of TPMS displays

| Function | Message + Symbol (Area B2) | Vehicle Symbol (Area B1) | Recovery (no connection) | TYRES screen page can be displayed on request | |
|--|--|---------------------------------------|--|---|-----------------------------|
| | | | | In normal conditions | Recovery (no connection) |
| Calibration in progress | Calibration activated + Tyre (green) | - | Generic failure symbol + specific symbol + “Electrical system failure” message for 20 sec. After 20 sec. or when the MODE button is pressed, the generic failure symbol is minimised | Vehicle symbol in the centre of the display with tyre pressure and temperature values replaced by dashes. | Not recallable |
| TPMS failure | TPMS failure + Tyre (amber) | - | | Not recallable | |
| Tyre puncture | Low tyre pressure Do not proceed + Tyre (amber) | Vehicle with yellow punctured tyre | | Vehicle symbol in the centre of the display with tyre pressure and temperature values and punctured tyre shown in yellow | |
| Tyre puncture (when the system does not recognise the punctured tyre) | Low tyre pressure Do not proceed + Tyre (amber) | - | | Not recallable | |

Summary of TPMS displays

| Function | Message + Symbol (Area B2) | Vehicle Symbol (Area B1) | Recovery (no connection) | TYRES screen page can be displayed on request | |
|--|--|---------------------------------------|--|---|-----------------------------|
| | | | | In normal conditions | Recovery (no connection) |
| Run Flat puncture after 100 km (62 mi) | Low tyre pressure Do not proceed + Tyre (amber) | Vehicle with yellow punctured tyre | Generic failure symbol + specific symbol + “Electrical system failure” message for 20 sec. After 20 sec. or when the MODE button is pressed, the generic failure symbol is minimised | Vehicle symbol in the centre of the display with tyre pressure and temperature values and punctured tyre shown in yellow | Not recallable |
| Run Flat puncture (or if a speed of 80 km/h is exceeded) | Low tyre pressure Max speed 80km/h + Tyre (amber) | Vehicle with yellow punctured tyre | | | |
| TPMS temporarily inactive | TPMS temporarily inactive + Tyre (amber) | - | | Not recallable | |
| TPMS inactive | TPMS inactive + Tyre (amber) | - | | Not recallable | |

TAB 1. child restraint systems that can be installed with 3-point seat belts - 2-seater version

| GROUP | WEIGHT RANGE | SEAT |
|-------|--------------|-----------------|
| | | Front passenger |
| 0 | 0 - 10 kg | X |
| 1 | 9 - 18 kg | UF - L |
| 2 | 15 - 25 kg | UF - L |
| 3 | 22 - 36 kg | UF - L |

TAB 2. Child restraint systems that can be installed with 3-point seat belts - 2 + 2-seater version

| GROUP | WEIGHT RANGE | SEAT | |
|-------|--------------|-----------------------|--------------------------------|
| | | Driver-side side rear | Opposite driver-side side rear |
| 0 | 0 - 10 kg | X | U - L |
| 1 | 9 - 18 kg | U - L | U - L |
| 2 | 15 - 25 kg | U - L | U - L |
| 3 | 22 - 36 kg | U - L | U - L |

TAB 3. Child restraint systems that can be installed with ISOFIX - 2 + 2-seater version

| GROUP | WEIGHT RANGE | SEAT | |
|-------|--------------|-----------------------|--------------------------------|
| | | Driver-side side rear | Opposite driver-side side rear |
| 0 | 0 - 10 kg | X | L |
| 1 | 9 - 18 kg | L | L |
| 2 | 15 - 25 kg | X | X |
| 3 | 22 - 36 kg | X | X |

TAB 4. Special Ferrari Baby Smart™ child restraint systems (Produced by Britax-Römer)- 2 + 2-seater version

| GROUP | WEIGHT RANGE | Name |
|-------|--------------|---------------|
| 0 | 0 - 10 kg | BABYSAFE Plus |
| 1 | 9 - 18 kg | DUO Plus |
| 2 | 15 - 25 kg | KID Plus |
| 3 | 22 - 36 kg | KID Plus |

Key

U = suitable for “Universal” category restraint systems homologated for use in this weight group.

UF= suitable for forward-facing “Universal” category restraint systems homologated for use in this weight group.

L = suitable for the special restraint systems listed in TAB 4. These restraint systems can be “vehicle specific”, “limited” or “semi-universal”.

B = built-in restraint system homologated for this weight group.

X = seat not suitable for children in this weight group.

1. General

2. Quick reference guide

3. Safety

4. About your vehicle

5. Advice for Emergency Situations

6. Care of the vehicle

7. Glossary

8. Table of Contents



Doors

Opening from the outside

Using the remote control, deactivate the alarm and the central door locking system, or turn the key in the lock to deactivate the central door locking system.

When pulling the handle **A** to open the door, the window moves down approximately 2 centimetres. When the door is closed, it will move back up until it meets the upper limit.

Locking and opening the doors from the inside

Warning



Always check that the door is closed properly to prevent it from opening while driving.



When pulling handle **B** to open the door, the window will move down to its “*target position*”.

When the door is closed, it will move back up until it meets the “*upper weather strip*”.

If the handle **B** is pulled without opening the door, the window will lower to the “*target position*” but, after 2 seconds, if the door is not opened, the window moves up to the “*upper weather strip*”.

Therefore, to open the door, release the handle **B** and pull it again.

Press the “**LOCK**” **C** button on the roof to lock both doors and press the “**UNLOCK**” **C** button again to unlock them.

Engine compartment lid

Opening

To unlock the engine compartment lid, pull the lever **D** underneath the steering column.

Release the lever **E** retaining the lid. This lever is located in the front section of the vehicle in a central position.

The lid is held open by two shock absorbers **F**.

Closing

Lower the lid until it is closed and press down near the lock until you hear it click in place.

Warning



Always check that the lid is closed properly to prevent it from opening while driving.

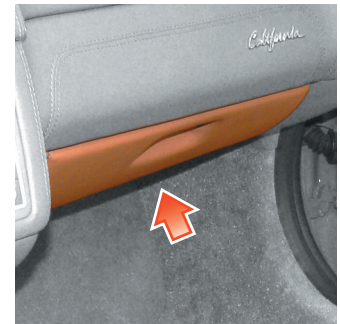
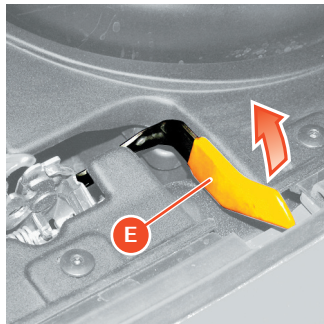

Emergency Opening

If the lid opening lever does not work, there is a string for manual emergency opening underneath the dashboard near the foot rest area on the passenger side as shown by the arrow in the figure.

Luggage compartment lid

Opening

To open the luggage compartment lid, press button **H** or button **L** on the remote control and hold it for more than 2 seconds. You can also use the special knob to the right of the number plate lights.

The luggage compartment is illuminated by an internal light that comes on automatically when the luggage compartment lid is opened.

Closing

Using the grip on the inside, lower the luggage compartment lid until it touches the bodywork.

The lock will pull the lid down until it clicks in place.

Warning



Since the lock closes automatically, always keep your hands away from the area between the luggage compartment lid and the bumper.



Fuel tank cap and flap

Warning



Always turn off the engine during refuelling. Take extreme care when removing the cap.

Do not smoke or use open flames when refuelling.

The following can be harmful for your health:

- fuel coming into contact with your skin
- inhaling fuel vapours.

Opening

To open the fuel tank cap flap, press button **M** to the left of the driver-side floor.

Unscrew the cap **P**, rotating it counterclockwise and hang it on the hook **Q**.

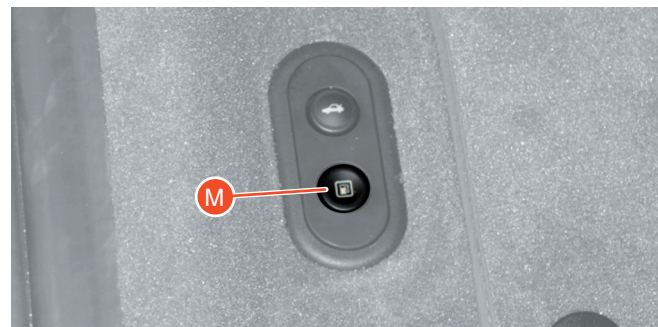

Closing

Screw the cap **P** back on tightly and close the fuel filler flap.
Make sure that the string **R** is not hanging out of the fuel filler flap.

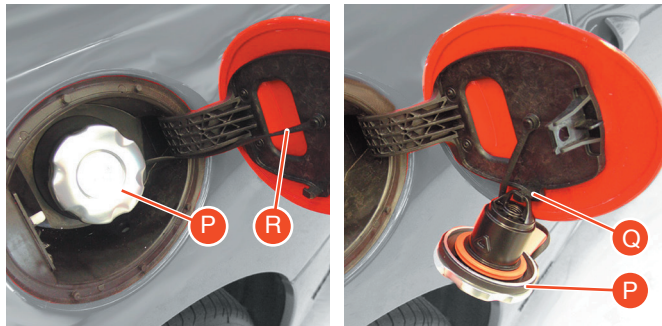

Emergency Opening

In the event of a failure of the fuel tank cap flap button, the flap can be opened manually.

Open the luggage compartment lid, turn the lock **E** and open the flap **F**.

Pull the emergency string **G**.

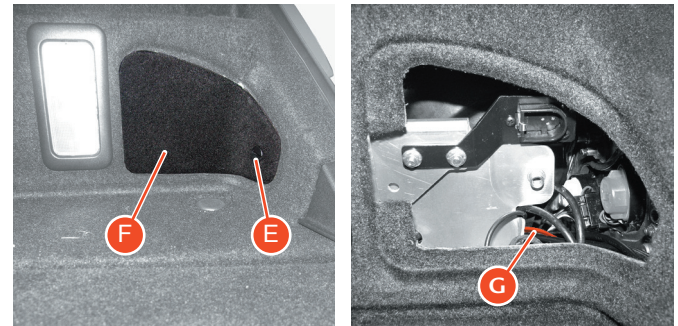

Power windows

The power windows can only be used with the ignition key in position II.

Driver-side power window

Press button **A** to move the window up or down. This button allows manual operation (partial opening/closing) or automatic operation (complete opening/closing). Press button **A** briefly to activate manual operation; if the button is pressed at length (over 0.3 seconds) the automatic window operation is activated. The window will only stop when it reaches the end of its travel or by pressing the button again.

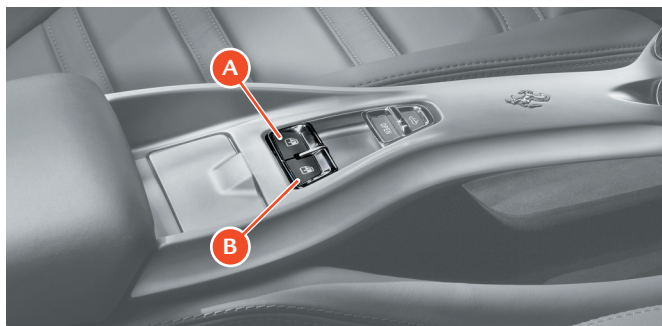

Passenger-side power window

Press button **B** to move the window up or down.

Only manual operation is possible (partial opening) to raise the window: when button **B** is released, the window stops at the position reached.

To lower the window, automatic operation is also possible (full opening): if the button is pressed at length (over 0.3 seconds) the automatic window operation is activated. The window will only stop when it reaches the end of its travel or by pressing the button again.

When the door is open, the window can only rise to the “*target position*”, to prevent the window from colliding with the upper weather strip when it is closed.

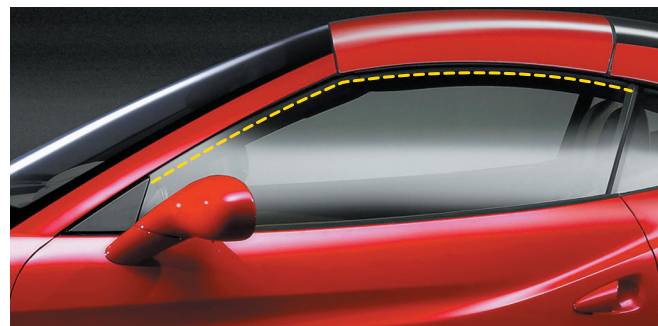

“Global Open” function

Quickly press the “Retractable hard top” button twice to open all four windows at the same time.

“Global Closed” function

Quickly press the “Retractable hard top” button and then hold it down to close all four windows at the same time.

Rear power windows

With the driver side front window lowered, press button **A** again to lower the driver side rear window.

With the passenger side front window lowered, press button **B** again to lower the passenger side rear window.

To raise the rear windows, simply lift button **A** for the left window and **B** for the right window.

Warning



Improper use of the power windows can be dangerous. Before use, always check that people and objects are at a safe distance.

Pay particular attention during the automatic operation of the driver-side power window.

To protect the passengers remaining in the car against accidental operation of the power windows, always remove the key from the ignition.

Instruments and gauges



- 1 TFT Display
- 2 Electronic speedometer
- 3 Rev Counter
- 4 Gear display
- 5 Warning lights
- 6 Manettino status
- 7 Fuel level

Electronic speedometer

The speedometer indicates the effective speed of the vehicle.

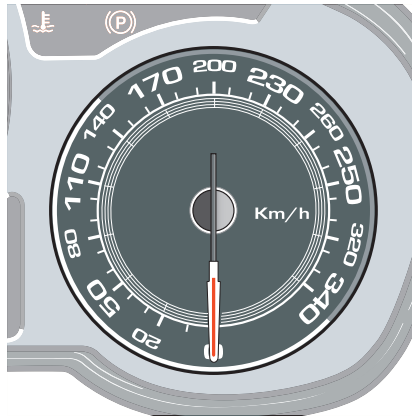

Rev Counter

The rev counter indicates the engine RPM.

The numbers on the dial multiplied by 1000 correspond to the engine RPM in one minute.

There is a space to the bottom right of the rev counter for the "DOT MATRIX" display which gives information on the "Semi-automatic gearbox".



Retractable hard top

The hard top system is composed of three main moving parts:

- top part
- rear part with rear screen
- luggage compartment lid.

Opening and closing is actuated by a hydraulic system, driven by a pump and controlled by a number of sensors that check every phase of opening and closing.

Warning



For safety reasons, the retractable hard top can only be opened and closed when the vehicle is stationary.

Warning



The roof must be opened or closed whilst remaining correctly seated in the driver's seat.

Warning



Before activating the roof and while it is in motion, always check that people and objects are at a safe distance from the moving parts of the roof. In the event of danger, release the roof switch; all movement will stop immediately.

Important note



Before opening or closing the hard top, refer to "Placing suitcases in the luggage compartment" on page 177.

Warning



Before operating the retractable hard top, make sure that the backrest of the child restraint system is set to its minimum height.

The preliminary steps for opening and closing the retractable hard top are:

- vehicle must be stationary
- luggage compartment must be closed
- battery voltage must not be below 11 volts
- partition between luggage compartment and folded roof compartment must be in the correct position, fully pushed back and fastened

Warning



Do not place items above the partition! Risk of serious damage to opening and closing mechanisms.



- check there is adequate space heightwise and in the rear of the vehicle: the minimum available height **A** must be 1700 mm, the minimum distance **B** of an obstacle from the rear must be more than 400 mm.
- ignition key in position II and engine running

Important note



We recommend operating the retractable hard top with the engine running.

Important note



If distance **B** is less than 400 mm, the parking sensors will not allow the roof to open or close.

The parking sensors are only activated when the key is in position **II**.

- no overheating of hydraulic system.

If one or more conditions are not met, the following message will appear on the TFT display.

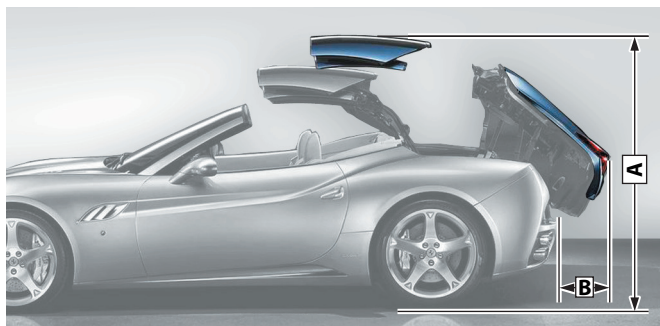

Roof opening using switch

Important note



Before opening the roof, ensure that the top of the roof and the rear screen are dry to avoid water entering the passenger compartment or luggage compartment.

Pull back switch **A** on the centre console and hold until the roof is completely open.

The operation in progress will be indicated by a warning on the TFT display.

When the button is pressed, a series of operations required to open or close the retractable hard top begins:

- the side windows are lowered completely
- the rear screen is raised
- the luggage compartment lid rotates around a hinge fitted in its rear



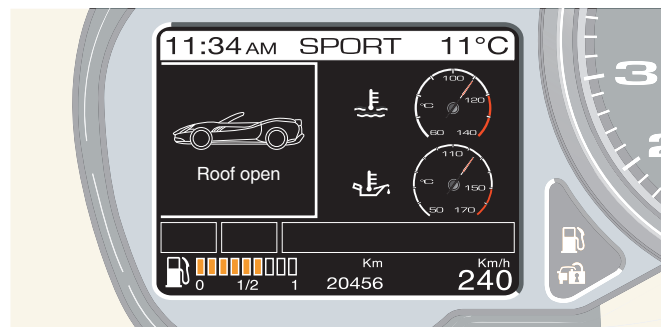
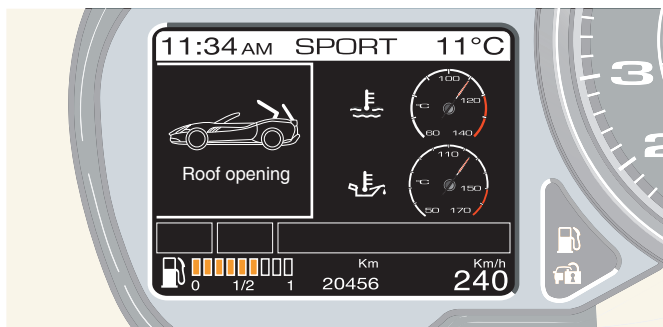

- the rear screen and luggage compartment lid parts are positioned in the luggage compartment
- the luggage compartment lid is closed.

Important note



Throughout all these phases, the side windows cannot be activated.

At the end of the opening cycle, an acoustic signal will indicate the end of operations and the phase will be indicated with a message on the TFT display.

Warning



Do not reverse the opening or closing direction when opening or closing the roof.

Always complete the cycle until the acoustic signal is emitted.

Roof closing using switch

Push forward switch **A** on the centre console and hold until the roof is completely closed.

The operation in progress will be indicated by a warning on the TFT display.

When the button is pressed, a series of operations required to open or close the retractable hard top begins:

- the side windows are lowered completely
- the luggage compartment lid lifts and rotates backwards
- the top part of the roof comes out of the luggage compartment and rests on the edge of the windscreen surround
- the luggage compartment lid completes the closing phase
- the rear screen starts moving back and goes into position.

Once the operation has been completed, an acoustic signal indicates that the switch can be released.

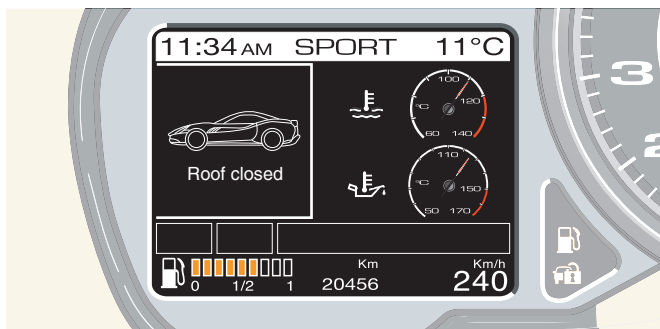

Standby operations

If the button is released before the retractable hard top has been completely opened or closed, a message will appear on the TFT display and will remain until opening or closing is reactivated.

Warning



Do not drive until opening or closing has been fully completed.

A few minutes after the roof is in standby position, an acoustic signal and message on the TFT display will prompt you to complete the operation.

Warning



Avoid leaving the hard top in a standby position.

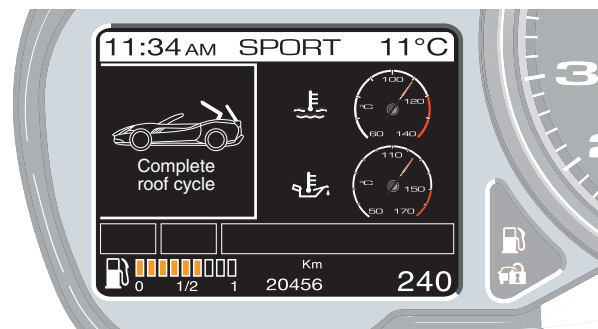

Disallowed operations

If the conditions for opening or closing the retractable hard top are not met, this will be indicated by an acoustic signal and a message on the TFT display:

- roof is activated when the vehicle is moving



- the speed signal transmitted via the CAN network is not detected by the ECU
- the luggage compartment has not been closed correctly

- battery voltage is below 11 volts



- partition between luggage compartment and folded roof compartment must be in the correct position, fully pushed back and fastened



- there is overheating of the hydraulic system
- the window position sensor detects that at least one of the windows is not in the correct position

- the parking sensors have detected an object in the rear of the vehicle

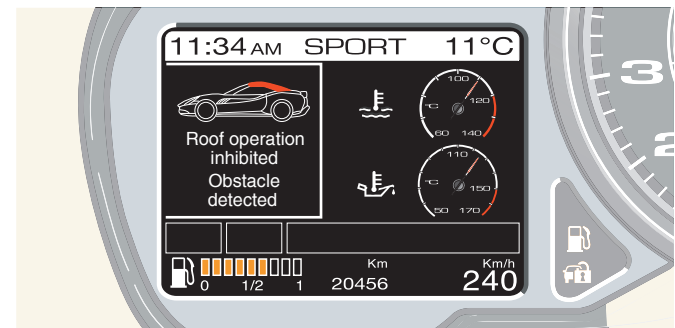

- the parking sensors are not communicating with the ECU.

Warning



DO NOT open the retractable hard top when the outside temperature is below -10 °C (14 °F).

Warning of faulty opening and closing

If there is a problem with opening and closing the roof, the fault will be indicated by an acoustic signal and a message on the TFT display.

After 20 seconds or after pressing the MENU button, the screen page is minimised to an icon and moves to the bottom left of the TFT display.

Warning



If there is a fault in the retractable hard top system, contact the **FERRARI SERVICE NETWORK**.

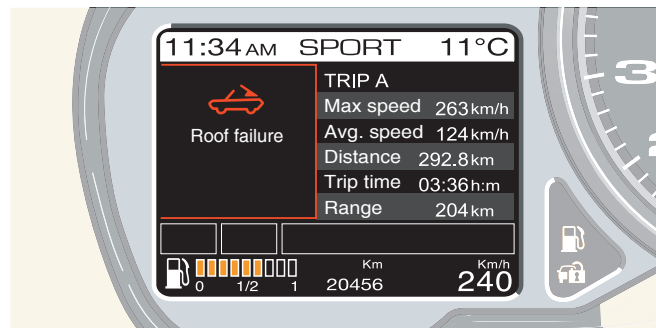



Lighting

The external lights and the direction indicators only work when the ignition key is in position II.

The external lights can be switched on and off manually or automatically, depending on daylight conditions.

Light switch

Switch **A** has five positions:

- 0** Lights off
-  Running and number plate lights on (*)
-  Low beams on (*)
-  Parking lights

AUT Automatic operation of the external lights according to the ambient light.

(*) The relative warning light on the instrument panel comes on.

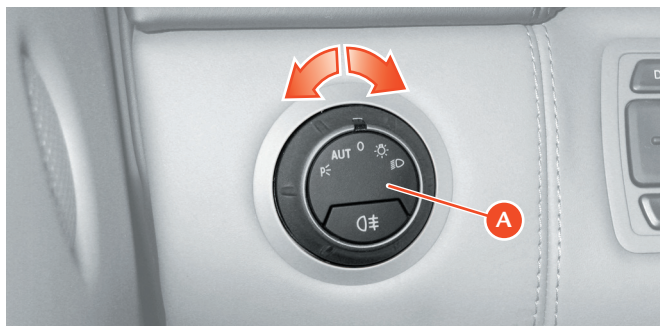

High beams

To turn on the high beams when the light switch **A** is set to , push the left-hand lever **B** towards the dashboard.

When the high beams are on, the relative warning light illuminates on the instrument panel .

Pull the lever **B** towards the steering wheel again to turn off the high beams and turn on the low beams.

Flashing the headlights

The headlights can be flashed by pulling the left-hand lever **B** towards the steering wheel.

Flashing occurs also with lights off if the ignition key is set to II. High beams are used for flashing.

Important note



Follow the Road Regulations of the country you are travelling in for using the high beams.

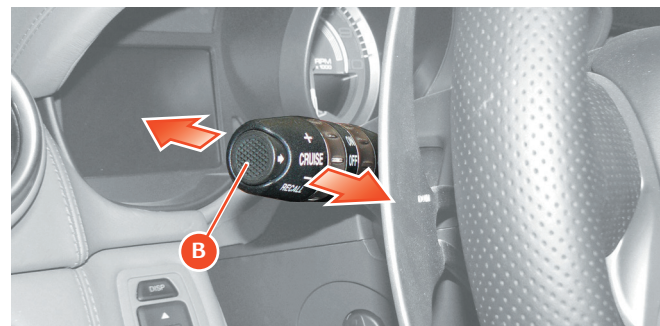

Parking lights

Parking lights work only with the ignition key in position **0** or with the key removed.

They are activated by turning the light switch **A** to position $\text{P} \leq$.

When the parking lights are on, the warning light illuminates on the instrument panel $\text{P} \leq$.

When the parking lights are on, move the left-hand lever **B** downward to turn on the left-side running lights. Move the lever upward to turn on the right-side running lights.

When the partial parking lights are on (lights only on one side of the vehicle), the running light warning light $\text{P} \leq$ turns off whereas a special message is displayed on the TFT display for 10 seconds.

When the light switch **A** is turned to **AUT** and the ignition key is in position **II**, the running lights, low beams and number plate lights turn on and off according to the ambient light.

Important note



The high beams can only be activated manually, by pushing the left-hand lever **B** towards the dashboard.

Important note



If the high beam control is activated, the high beams will turn on every time the lights are activated automatically. We recommend therefore that you turn them off every time the twilight sensor deactivates the external lights.

Warning



If there is fog during the day, the running lights and low beams will not be turned on automatically. The driver must always be ready to turn on the lights manually and also the rear fog lights, if necessary.

Important note



After automatic activation of the external lights, it will always be possible to turn on the rear fog lights manually. When the external lights are deactivated automatically, the rear fog lights are also turned off (if active) automatically. Therefore, if necessary, the driver will have to turn on the rear fog lights manually upon the next automatic activation.

Warning



The driver is always responsible for turning on the external lights, depending on the ambient light and in compliance with the regulations in force in the country of use. The automatic system for turning on and off the external lights must be considered an aid for the driver. If necessary, turn the lights on and off manually.

Twilight sensor

The twilight sensor is comprised of a global sensor, which measures the ambient light upwards.

In the event of sensor failure, the system switches on low beams and running lights irrespective of daylight conditions; a failure message will appear on the instrument panel display.

The failure indication will be displayed as long as the light switch A is turned to AUT.

In this case, we recommend that you deactivate the automatic system and turn on the external lights manually if necessary.

Important note



Contact the **FERRARI SERVICE NETWORK** as soon as possible.

Direction indicators

When lever **B** is:

- moved up, the right-hand direction indicators are turned on;
- moved down, the left-hand direction indicators are turned on.

The relative warning lights  or  will illuminate on the instrument panel.

The lever returns to the neutral position automatically when the steering wheel is straightened.

To indicate a temporary lane change, requiring only the slightest turn of the steering wheel, the lever can be moved without clicking it into position (non-permanent position).

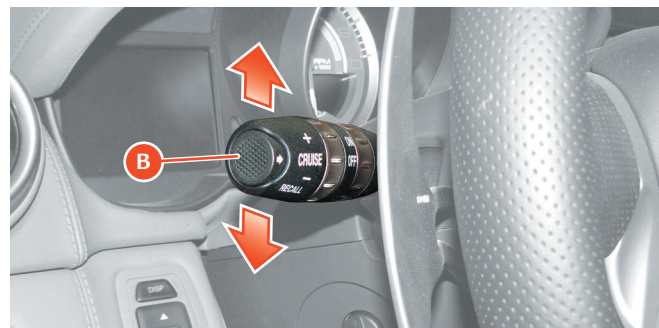

Rear fog lights

These can be activated only when the high or low beams are on, by pressing button **D**. The relative warning light **E** on the instrument panel will turn on.

Important note



Use the rear fog lights only in poor visibility conditions.

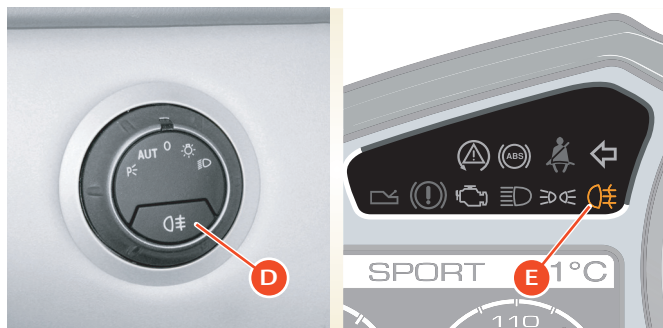

Hazard warning lights

Press button **A** to turn on the hazard warning lights. All the direction indicators will start blinking intermittently. These lights will operate with the ignition key in any position.

When the lights are on, the relative warning lights on the instrument panel and the button flash.

To turn them off, press the button again.

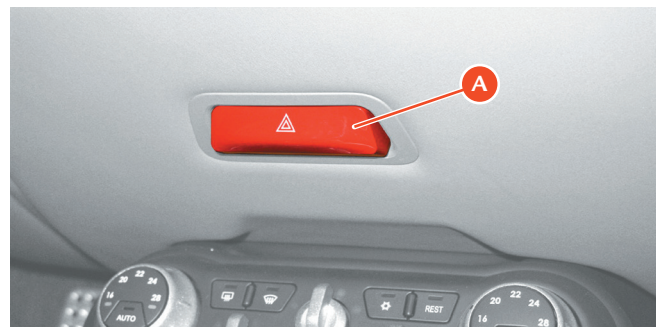

Adaptive light system (optional)

The “Adaptive Light” system not only illuminates the road better but also avoids the shadowy areas in the curved trajectory of the vehicle.

The beam angle is defined by the following parameters:

- steering angle
- vehicle speed
- lateral acceleration.

To avoid shadowy areas when driving on bends, the lighting direction of the beams varies from 7.5° inwards and 15° outwards.

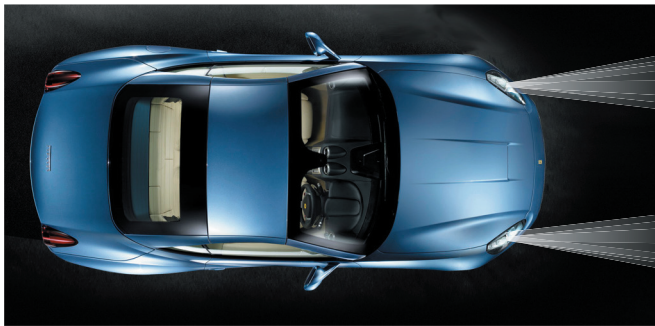

Dome light

When the doors are closed, the dome light **D** on the roof can be turned on or off using the switch **E**.

Switch **F** is used to turn on the driver side spotlight and switch **G** turns on the passenger side spotlight.

The dome light activates automatically in the following conditions:

- when a door is opened, for approx. 3 minutes
- when all the doors are closed and the key is in position 0, for approx. 10 seconds
- when the key is removed, for approx. 10 seconds
- when the doors are unlocked, for approx. 10 seconds
- when the inertia switch is activated, for approx. 15 minutes.

The dome light deactivates automatically in the following conditions:

- after the preset activation time expires
- when the doors are closed and the key is in position II
- when the doors are locked
- when the inertia switch is reactivated.

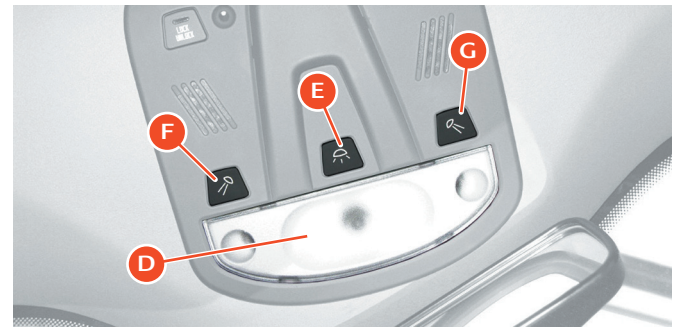

“TFT” display

Located on the instrument panel, it performs the following functions:

- indication of the control parameters
- indication of general information while driving
- fault warnings.

The driver can interact with the system by choosing graphic configurations and setting the parameters.

The screen is activated and set by pressing the buttons DISP (**H**), MODE (**L**) and UP, DOWN (**I**) on the dashboard to the left of the steering wheel.



Six different screen areas are available, depending on the display type chosen:

- A** - display of clock, selected driving mode indication (“Manettino” position), outside temperature and “Warning: danger of ice” icon
- B** - display of virtual control gauges and information generated by specific events and/or on request, engine coolant temperature/engine oil temperature gauges, parking sensor screen page, display of abnormal events / warnings with messages and special symbol when available
- C** - display of 0/1/2 priority level faults (see page 139), engine coolant temperature/engine oil temperature gauges
- D** - audio info / check - check OK indication / “Calling” info
- E** - fuel level gauge, total or trip odometer (TRIP A or B) / range
- F** - speedometer repeater.

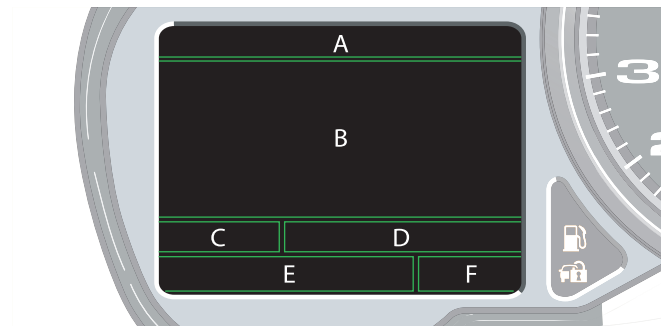

Parameters shared by all the configurations

Clock

The clock is always displayed to the right in area **A** in all configurations and can be viewed in the “24h” or “12h – AM/PM” format.

Date and hour

The data in the Trip A/ Trip B screens is displayed in the day of week (e.g. Mon.) mm format. It can be set using the UP and DOWN buttons through Menu function. To confirm, press MODE.

The time may be displayed in the “24h” or “12h – AM/PM” format. To select the format and set it, use the UP and DOWN buttons through Menu function. To confirm, press MODE.

Outside temperature gauge

The information is displayed to the left in area **A**.

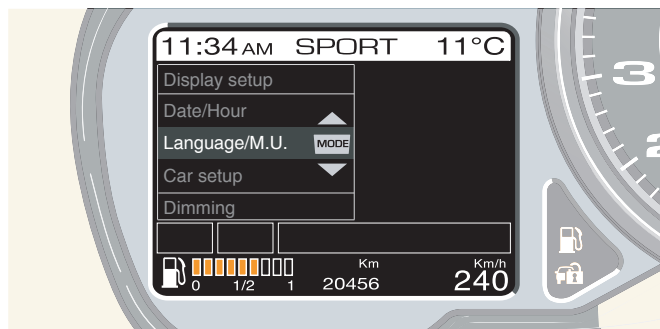

Configuration settings

Menu Page

To display the MENU page, press the DISPLAY button.

The parameters that may be set are:

- Dimming
- Display setup
- Date and hour
- Language and M. U.
- Car setup
- Calibrate TPMS
- Service.

To select the above mentioned parameters and the related functions, use the UP and DOWN buttons.

To confirm the selected parameter, press MODE.

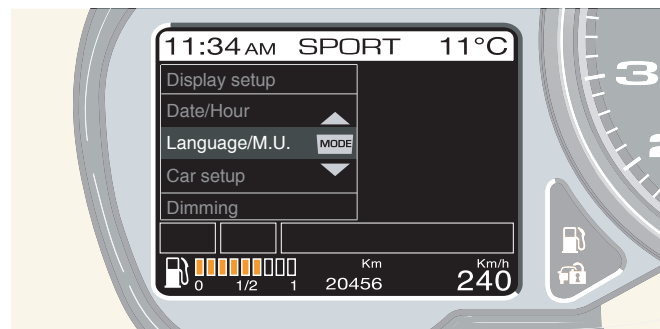

KEY ON

Upon key-on, the check procedure is started and, regardless of the main screen page, the message “Check” is immediately displayed in area **D** on a grey background divided into 5 “segments” that are gradually highlighted as the 5 seconds elapse.

- 1 the initial check time of the warning lights on the dial has elapsed
- 2 the engine RPM has exceeded the set value, from the moment that this threshold is exceeded
- 3 the check procedure has been successfully completed (no failures)
- 4 the Service information has been displayed for 5 seconds (when provided)

Subsequently, the “Check OK” message will appear.

If only conditions **1, 3, 4** are met (no engine start), the previously saved main screen will appear directly (also after a key-off/key-on).

The “Check OK” message is displayed as soon as condition **2** is met provided the others are maintained.



DISP (DISPLAY) button

Press the DISP button to display the following screen pages:

- SPORT
- TYRES
- TRIP A/B
- MENU

MODE button

When pressed for less than 2 seconds:

- if the **MENU** screen is not displayed: it switches between total odometer information, “travel distance” **TRIP A**, “travel distance” **TRIP B** (if enabled) and range
- if the **MENU** screen is not displayed and the odometer flashes: it resets the Trip information for the flashing odometer (**TRIP A/B**)
- if the **MENU** screen is displayed:
 - it confirms the selected function
 - it confirms the setting/change and returns to the previous screen (same item) when in the submenu functions in the main **MENU**
 - it stores the confirmed changes
 - it exits the display of the various check phases at key-on
 - the malfunctions are iconised if the button is pressed during fault warning display cycles.

When pressed for more than 2 seconds:

- if the **MENU** screen is displayed: it takes you back to the previous level in the **MENU** (when in the submenu functions)
- if the **MENU** page is not displayed:
 - if total odometer, travel distance **TRIP A** or Range information is displayed, Odo A information flashes in the same area
 - if travel distance **TRIP B** is displayed, Odo B information flashes in the same area
- if the **MENU** page is not displayed and **TRIP B** is disabled: it resets **Trip A**.

UP / DOWN button

The UP/DOWN button is a single button divided into two parts, the top part corresponds to the UP control and the bottom part corresponds to the DOWN control:

- sets/adjusts the functions on the **MENU** page
- **MENU** page not active: adjusts the instrument panel brightness level
- Auto function (twilight sensor active): adjusts the sensor's sensing range.

SPORT

In addition to the shared parameters, the screen page shows the virtual control gauges, for:

- water temperature
- oil temperature.

When the SPORT screen page is displayed and an event occurs that needs to be viewed, the display will appear as in the following example:

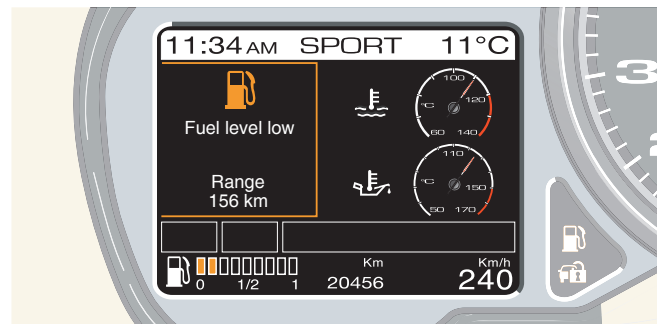

In case of malfunctions/events which need to be displayed through a multifunction symbol, this will be viewed at the end of the display cycle, in one of the three dedicated sections of area C.

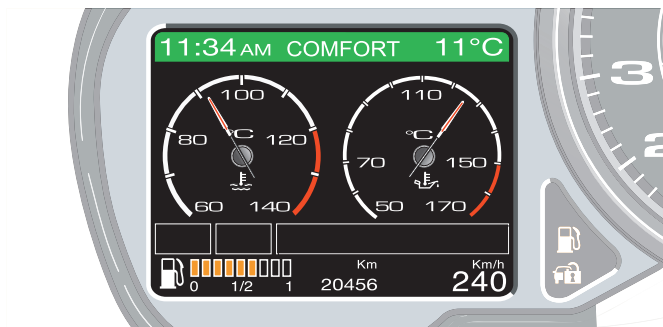

TRIP A/B

The screen page displays information on the following parameters:

- maximum speed
- average speed
- travel distance
- travel time
- range
- date.

When displaying the parameters, the zeros to the left of the most significant figure are deleted.

If an event occurs that needs to be viewed when the Trip A/B screen page is being displayed, the Trip information is minimised:

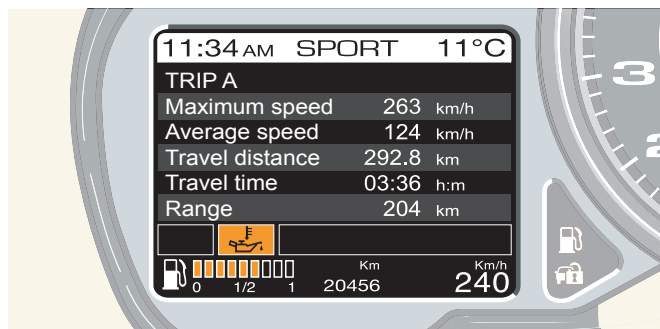

TYRES (tyre temperature and pressure display)

The Tyres screen page includes a vehicle symbol which indicates the pressure and temperature levels for each tyre.

If an event occurs that needs to be viewed when the TYRES screen page is being displayed, the screen is minimised.

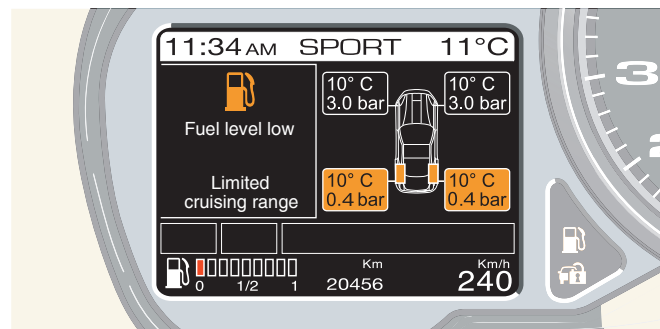
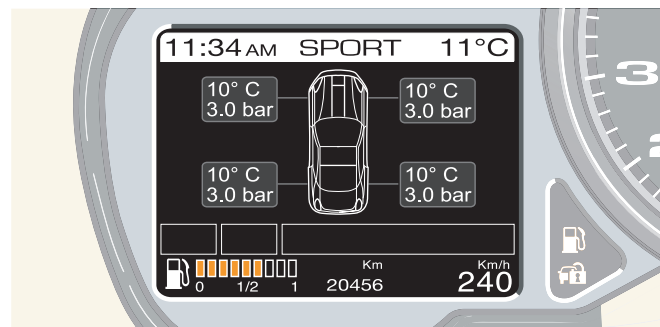

MENU

The Menu screen is accessed using the “Display” button. The Menu screen can be displayed at several levels; here is an example of a display for a selection at levels:

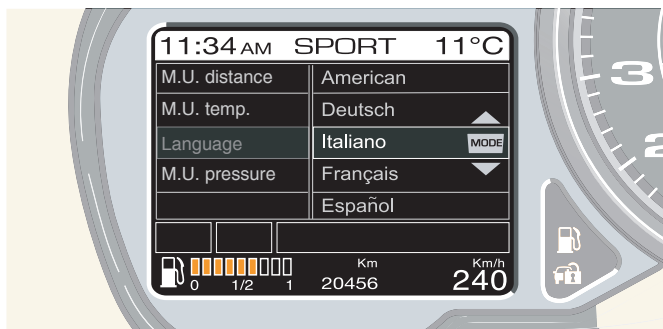
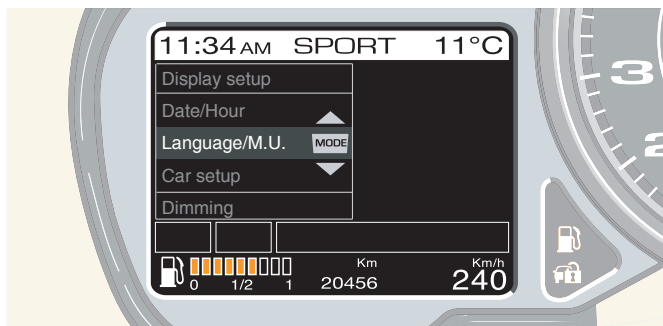

If an event occurs that needs to be viewed when the Menu screen page is being displayed, the display depends on the selected menu level:

First level

The event will be displayed in the dedicated area (area B) whereas the Menu with the main items only will be moved to the right of the display.

From the second level onwards, the new event will be displayed over the Menu screen.

In any case, when a new event is being displayed, the menu functions cannot be accessed and they will be displayed with a “softer” background.

At the end of the new event display cycle, the menu level that was active before the new event was displayed will be restored.

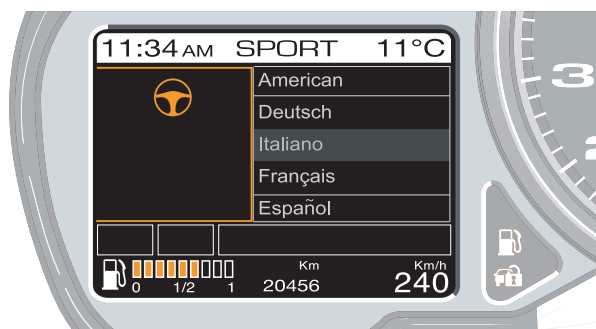

Fuel level gauge

This information is always present on the display (Area E).

The gauge has 9 yellow bars that gradually “go out” as the fuel level drops.



When the second notch goes out, the last notch turns red; this notch will remain lit until the fuel runs out.



When the “fuel reserve” condition is reached, a message with symbol is displayed for 10 seconds followed by an acoustic signal in the dedicated area in addition to the warning light lighting up on the panel.

If the vehicle is already in a limited range condition, the range signal will be replaced by a “Limited cruising range” message and the screen page will appear as in the example:

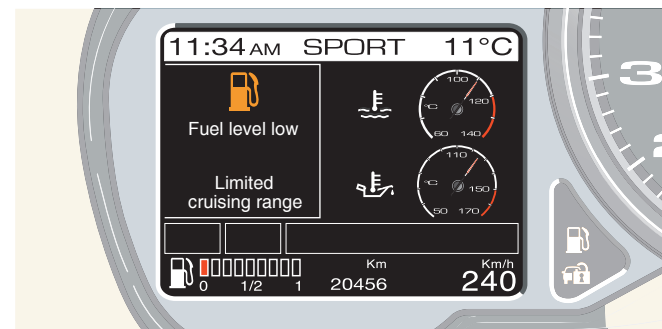
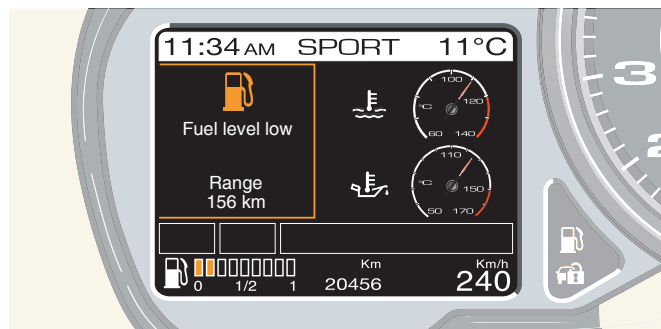

“Warning: danger of ice” display

To warn the driver of the presence of ice on the road if the outside temperature is 3 °C (38 °F), the “snow” symbol and ice hazard message must be displayed for 10 seconds in the top right of the display.

After the display cycle ends, the message disappears and the screen that was present prior to the event reappears. The “snow” symbol moves to the right next to the outside temperature gauge until the temperature remains below 6 °C (43 °F).



“Adaptive Light Control” function display

When a failure in the adaptive light system is detected on a bend, the warning light flashes on and off and at the same time, a message with a special symbol is displayed:

The message is displayed for a set period of time. When this period expires, the screen page disappears but the warning light continues to flash until the situation has been corrected.

The next time the engine is started, if the failure persists, the warning light will flash on and off and the same screen described above will be displayed.



“Speed limit” function display

Using the menu a speed limit can be set between 30 and 250 km/h with steps of 5 km/h which, if exceeded, activates the following procedure that warns the driver.

A symbol and “speed limit exceeded” message appear in the top right of the display accompanied by an acoustic signal.

Once the warning cycle has ended, the message disappears whereas the symbol only disappears when the speed of the vehicle drops 5 km/h below the set limit.

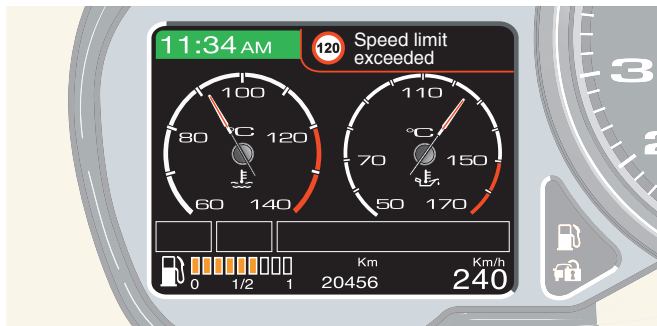

“Doors/Engine or luggage compartment lid open” function display

When doors and the engine compartment or luggage compartment lid are open, this is signalled by a screen page in which several doors/lids which are open at the same time can be indicated by specific icons.

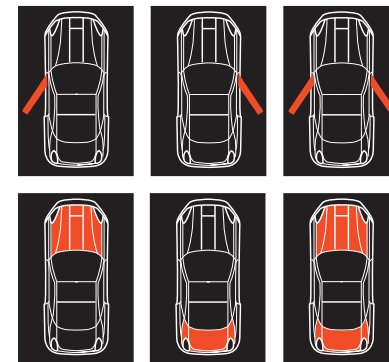
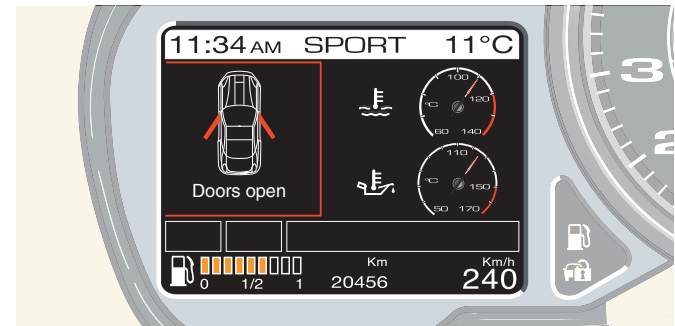

“Tyre pressure and temperature” display

The screen page showing the pressure and temperature values of each tyre can be accessed using the “Display” button.

When the on-board instrument panel receives the signal from the tyre pressure ECU that the pressure level of one or more tyres is below the alarm threshold, a different screen will appear according to whether the value is low on one or more tyres.

Refer to “Tyre pressure and temperature monitoring system” on page 87.

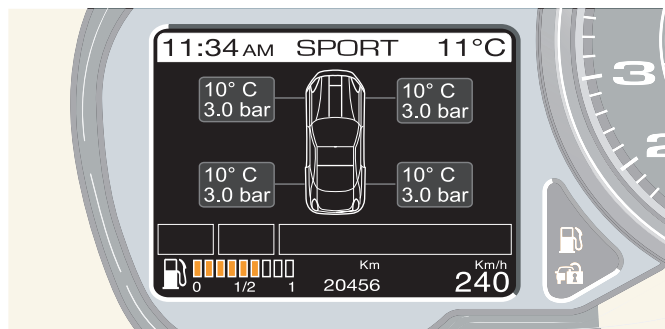

“Tyre puncture” display

When the pressure level of one or more tyres is below the alarm threshold, irrespective of the current display configuration, the warning light comes on permanently and a message and special symbol are displayed for vehicles fitted with normal tyres and one for those fitted with Run Flat tyres.

Refer to “Tyre pressure and temperature monitoring system” on page 87.

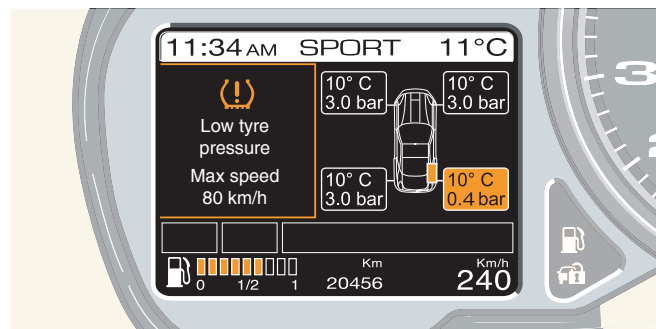
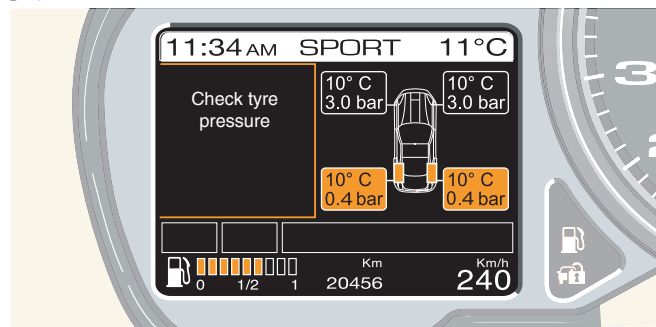

“Automatic Vehicle Holding” AVH system display

The AVH system is an integration of the EPB electronic parking brake. It blocks the callipers when the electronic parking brake is engaged in certain situations enabling faster deactivation of the parking brake than the EPB.

When the AVH system is activated, the word “HOLD” appears on the DOT MATRIX display.



External lights failure display

The following failures can be displayed:

- 1 Stop lights failure
- 2 Number plate lights failure
- 3 Rear fog lights failure
- 4 Running lights failure (front and/or rear)
- 5 Turn indicators failure (front and/or rear).

If one of these failures occurs, a specific message that highlights the faulty light is displayed.

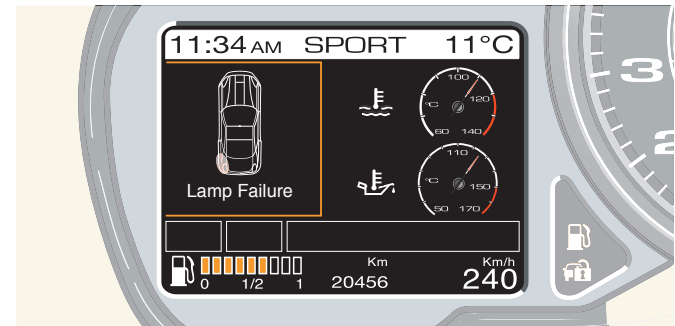

Dimming of lights

The brightness level of the TFT display can be adjusted using the MENU function.

When the MENU screen is not displayed, it can be adjusted by pressing the UP/DOWN buttons.

The first time one of the UP/DOWN buttons is pressed, the screen page is displayed. The next time the buttons are pressed, the brightness can be adjusted.

The adjustment made can be seen immediately and does not affect the brightness of the warning lights.

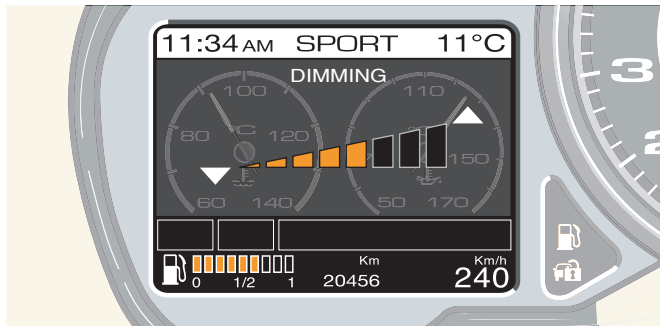

Parking sensors

To help the driver when parking, the vehicle has four sensors in the front and rear bumpers (optional).

Warning



The system will only operate correctly if the sensors on the bumpers are free of mud, dirt, snow or ice.

When approaching obstacles in front of or behind the vehicle, the sensors give the driver information on how far away the obstacle is. The information on the presence of the obstacle and how far away it is transmitted to the driver by way of acoustic signals, which become more frequent as the obstacle approaches, and visual signals on the TFT display.

By integrating direct visual information with the acoustic and visual information generated by the system, the driver can avoid coming into contact with obstacles when parking.

Warning



However, the responsibility when parking and in other potentially dangerous situations, remains that of the driver. Indeed, the system has only been designed as an aid when parking since it detects obstacles that are outside the driver's range of visibility.

The use of sensors is therefore not a substitute for the care and attention of the driver when parking and checking for the presence of persons or objects.

The parking system sensors in the bumpers are automatically activated with the key in position II (Ignition) when the reverse gear is engaged.

The rear sensors are also an aid when opening and closing the retractable hard top and reduce the risk of hitting obstacles placed behind the vehicle.

Important note



If distance **B** (see page 111) is less than 400 mm, the parking sensors will not allow the top to be opened or closed the 1st time the switch is pressed.

When the vehicle is also equipped with front sensors, only the rear sensors or front sensors can be activated/deactivated using the TFT display menu.

When the rear sensors are activated, an acoustic signal warns the driver that the system has been activated.

The system then starts to emit acoustic signals as soon as an obstacle is detected which become more frequent as the obstacle approaches.

When the obstacles is at a distance of less than 35 cm from the bumper, a continuous sound is emitted and the relevant area becomes red on the TFT display (minimum distance, see page 136).

The acoustic signal stops immediately if the distance from the obstacle increases.

The tone cycle remains constant if the measured distance from the central sensors remains unchanged.

The TFT display indicates the vehicle symbol and the sensor detection zones.

The detection zones indicate which part of the vehicle is approaching an obstacle (front/rear and left, right or central) and at what distance away it is (maximum, medium, minimum).

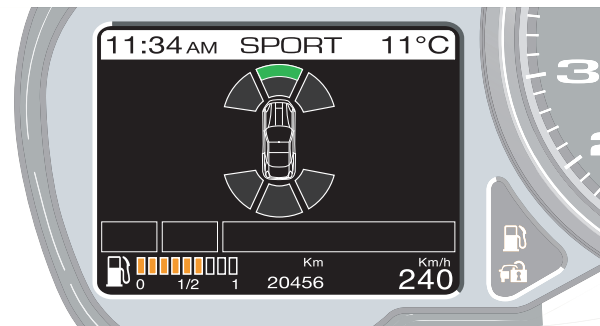

If an obstacle is detected at maximum distance in the central front part, it will be displayed as shown (green):

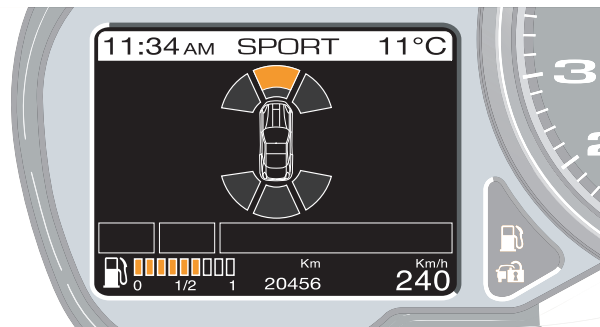

If an obstacle is detected at medium distance in the central front part, it will be displayed as shown (yellow):

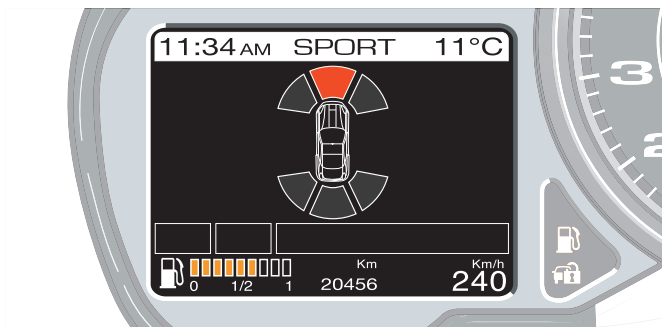

If an obstacle is detected at minimum distance in the central front part, it will be displayed as shown (red):

If the rear sensors are activated and the front ones are deactivated or not present, the TFT display does not display the symbols for the front part.

The TFT display can give several items of information at the same time.

If an obstacle is detected at a maximum distance in the front central part and at a minimum distance in the rear right part, it is displayed as follows:

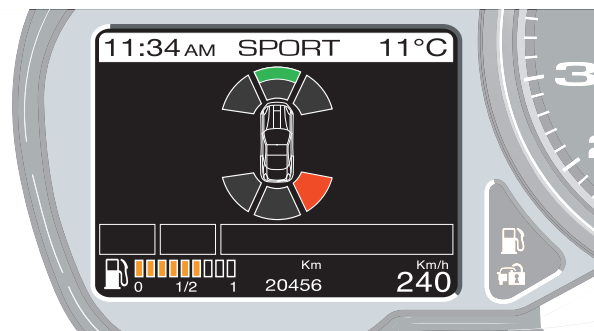

If another failure occurs when the parking symbols are being displayed, the TFT display will also show the message for the ongoing failure and the for the parking sensor symbol will move to the right of the display.

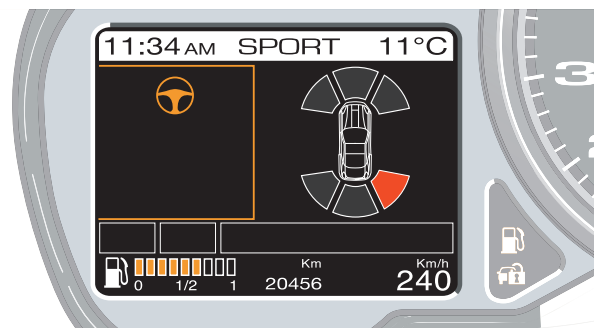

Important note



If there is higher priority failure such as a tyre puncture, the TFT display will indicate this failure and the parking sensor symbols will disappear.

Once the failure has been displayed, the parking sensor symbols will go back to the centre of the display.

Simultaneous display of parking sensors and other systems

When other systems start operating when the parking sensors are being displayed, the TFT display displays the sensors on the right of the screen and the other active system on the left.

If the hard top is operated, the parking sensor display is deactivated so that the sensors can concentrate on detecting obstacles that may damage the luggage compartment.

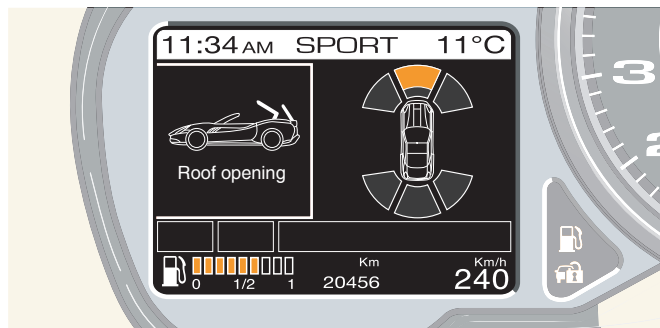

Cleaning the sensors

When cleaning the sensors, be very careful not to scratch or damage them; avoid the use of dry, rough or hard cloths.

The sensors must be washed with clean water and car shampoo added if necessary.

In car washes that use steam jet or high pressure water cleaning equipment, quickly clean the sensors keeping the nozzle at a distance of over 10 cm.

For the repainting of bumpers or retouching the paintwork in the sensor area, contact the FERRARI SERVICE NETWORK. If paint is applied incorrectly, it may interfere with the operating of the parking sensors.

Range of sensors

The sensors allow the system to control the rear and front of the vehicle and their position covers the central and side areas of the vehicle.

If an obstacle is in the central area, it is detected at distances of approximately 1.40 m depending on the type of obstacle and its size.

If an obstacle is in the side area, it is detected at distances of less than 0.8 m.

Failure signals

The system ECU checks all the components each time the reverse gear is engaged.

A parking sensor system failure is indicated on the TFT display (see page 143).

If there is a failure signal, stop the vehicle and turn the ignition key to position **0** (Stop). Then try and clean the sensors or move them away from any sources of ultrasound emissions (e.g. pneumatic brakes of lorries or pneumatic drills) and turn the ignition key to position **II** again. In this way, if the cause of malfunctioning has been removed, the system will start operating correctly again and the failure buzzer will stop.

If the failure buzzer continues, contact the **FERRARI SERVICE NETWORK** to have the system checked.

Important note



Obstacles that may damage the luggage compartment (obstacles at distances of less than **B**, see page 111) are detected only once by the rear sensors prior to hydraulic operating of the hard top. Any obstacles that appear once operating has started will not be detected.

Important note



The sensors are able to detect obstacles with reasonably large, even surfaces (e.g.: poles with diameters of over 60 mm, walls, barriers, trees). Detection is not optimum with obstacles with sharp projections or uneven surfaces.

Important note



When parking and operating the retractable hard top, always be very careful to avoid obstacles that may be above or below the sensors.

Important note



Objects placed close to the rear part of the vehicle are not always detected by the system and may therefore damage the vehicle or be damaged themselves.

Important note



The signals sent by the sensors may also be affected by damage to the sensors caused by dirt, snow or ice on the sensors or by ultrasound systems (e.g.. pneumatic brakes on lorries or pneumatic drills) in the vicinity.

Warning







However, the responsibility when parking and operating the retractable hard top and in other potentially dangerous situations, remains that of the driver. Indeed, the system has only been designed as an aid when parking and operating the hard top since it detects obstacles that are outside the driver's range of visibility.

The use of sensors is therefore not a substitute for the care and attention of the driver when parking and verifying the presence of persons or objects.

TFT display and instrument panel warning lights

Priority level 0 (Extremely critical malfunction): is displayed for 20 seconds.

Priority level 1/Priority level 2 (Critical malfunction/ Non-critical malfunction): is displayed for 20 seconds in the centre of area **B**. After 20 seconds the symbol remains displayed in minimised form if there is no specific warning light.

| TFT | Warning light | Description and warnings |
|---|---|--|
|  |  <i>Alarm system failure</i> | Indicates a fault in the alarm system (priority level 1). The system is not programmed (priority level 2). Failure and system not programmed (priority level 1). Alarm system failure (priority level 2). Break-in attempted (priority level 2). |
| Contact the FERRARI SERVICE NETWORK. | | |
|  |  <i>Fuel reserve</i> | Indicates that the fuel level is too low (priority level 2). |
|  | <i>Battery conditioner connected</i> | When the instrument panel is on, it indicates that the battery conditioner is connected (priority level 0). |



Inertia switch

Indicates activation of the inertia switch following an accident and the resulting cut-out of the fuel supply (priority level 0).

The hazard warning lights are also automatically activated.



Alternator failure

If the recharging system is faulty.
When the battery is insufficiently charged or overcharged (flashing).



Low windscreen washer fluid level

Indicates a low level of washer fluid in the windscreen washer tank (priority level 2).



Oil temperature

Indicates that the oil temperature is too high (priority level 0).



Adaptive light system failure

Indicates an adaptive light system failure (priority level 2).



Engine coolant temperature

Indicates that the engine coolant temperature is too high (priority level 0).

Turn off the engine and contact the FERRARI SERVICE NETWORK.



Oil pressure

Indicates that the oil pressure is too low (priority level 0).

Turn off the engine and contact the FERRARI SERVICE NETWORK.

Indicates a pressure sensor failure (flashing) (priority level 2).



On board diagnostic system (EOBD)

It indicates a malfunction in the emission control system and in the ignition/injection system.

After turning the ignition key to position **II**, this remains on for a self-check for a few seconds following engine starting.



Cruise Control on

Indicates that the Cruise Control has been turned on.



Running lights

When the running lights or low beams are turned on.



Stop lights failure

Indicates a system failure or blowing of the STOP light bulb (priority level 2).



Lights failure

Indicates a system failure or blowing of a bulb in the running, direction indicators or rear fog lights (priority level 2).



Number plate lights failure

Indicates a system failure or blowing of the number plate light bulb (priority level 2).



Rear fog lights

When the rear fog lights are turned on.



Twilight sensor failure

Indicates a twilight sensor failure (priority level 2).



Hard top failure

Indicates a failure in the retractable hard top (priority level 0).

The type of failure is specified by a special message on the display.



High beams

When the high beams are turned on.

When the high beams are used to flash.



Right direction indicators

When the right direction indicators are activated.



Left direction indicators

When the left direction indicators are activated.



Hazard warning lights

When the hazard warning light is activated.



Catalytic converter temperature

Indicates that the catalytic converter temperature is very high: slow down until the warning light goes off (priority level 1).

Indicates that the catalytic converter temperature is too high: stop the vehicle (priority level 0).

Contact the **FERRARI SERVICE NETWORK**.

Indicates a failure of the catalytic converter temperature sensor (priority level 0).



Checking the engine oil level

Indicates a low engine oil level.



Seat heating

Indicates that the seat heating function is activated (front RH/LH) (remains displayed for 5 seconds).



Power steering failure

Indicates that the power steering system is inefficient (priority level 2).

Contact the **FERRARI SERVICE NETWORK**.



ABS

Indicates an ABS system failure (priority level 1).

The standard braking system is still functioning.

Contact the **FERRARI SERVICE NETWORK**.



ASR + CST on

Indicates that the ASR and CST systems are active (priority level 1).



ASR + CST off

Indicates that the ASR and CST systems are deactivated (priority level 1).



ASR/CST failure (flashing warning light)

Indicates an ASR/CST system failure (priority level 1).

Warning



Stop the vehicle avoiding sharp braking. Stop driving and contact the **FERRARI SERVICE NETWORK** immediately.

Warning



The vehicle can still be driven at low speed (max. 40 Km/h) to free the road.



CCM brake discs worn

Indicates that the carbon ceramic discs are worn (priority level 2).

Contact the **FERRARI SERVICE NETWORK** to have the brake pads replaced.



ASR/CST system activation (flashing warning light)

Indicates that the CST system has activated (priority level 1).



TPMS System

Indicates a puncture in one or more normal tyres (priority level 0).
Warning light connected to the tyre pressure monitoring system (priority level 0/2).
Indicates a puncture in one or more Run Flat tyres (priority level 2).
Indicates a failure in the TPMS (priority level 2).
Indicates that the TPMS is not activated (priority level 2).
Indicates that the TPMS is not calibrated (priority level 2).



Airbag system failure (flashing warning light)

Indicates a system failure (priority level 0).

Contact the **FERRARI SERVICE NETWORK**.



Driver-side seat belt not fastened

Indicates that the driver-side seat belt has not been fastened (priority level 0) together with an acoustic signal lasting 90 sec.



Passenger-side seat belt not fastened

Indicates that the passenger-side seat belt is not fastened (priority level 0).



Speed limit exceeded

Indicates that the speed set by the driver has been exceeded (priority level 2), the figure shown indicates the set speed.



Brake malfunction

Indicates that the brake fluid is low (priority level 0).
Indicates an EBD system failure (priority level 0).
Indicates an EPB system failure (priority level 0).
Indicates an overhaul of the Parking Brake system (priority level 0).



Rain sensor failure

Indicates a rain sensor failure (priority level 2).



Suspension control system failure

Indicates a malfunction in the suspension control system (priority level 2).

Contact the **FERRARI SERVICE NETWORK**.



Generic failure

Indicates an Air Bag warning light failure (priority level 2).

Indicates a Manettino failure (priority level 1).

Indicates an electrical system failure (priority level 2).



TPMS System

Indicates that calibration of the TPMS has been activated.



Brake pad wear

Indicates excessive wear of the brake pads (priority level 2).



Activation of passenger air bag

Indicates that the passenger air bag has been activated.



Deactivation of passenger air bag

Indicates that the passenger air bag has been deactivated.



Parking sensor failure

Indicates a parking sensor system failure (for vehicles provided with one) (priority level 2).



Telephone

Indicates that the “Telephone repetition” function has been activated for incoming, outgoing or active calls.



Scheduled Maintenance (Service)

Indicates the Scheduled Maintenance expiry date.



AVH system

Indicates an AVH system failure.



Ice hazard

Indicates that the outside temperature is 3 °C (38 °F) or lower, highlighting the risk of icy road surfaces.

Drive carefully and slow down as the grip of the tyres is markedly reduced.

Warning



In this condition, do not activate the “SPORT” mode.



Gearbox failure

Indicates a system failure (priority level 1).

Contact the **FERRARI SERVICE NETWORK**.

Electronic speedometer

It indicates the vehicle speed.

At a speed of between 0 and 5 km/h, the indicator may remain in an idle state. With higher speeds, it indicates the acquired speed.

Rev counter

The electronic rev counter indicates the engine RPM. Avoid engine speeds in the red sector.

DOT MATRIX semiautomatic gearbox display

The DOT MATRIX display is to the bottom right of the rev counter; with the ignition key in position II, it displays the following information:

Gear engaged (DCT gearbox)

“Auto” gearbox mode (DCT gearbox)

“Auto easy exit” gearbox mode (DCT gearbox);

Performance

AVH system activated.

Important note



Information on the gearbox is useful in all operating conditions.



Gear engaged (DCT gearbox)

Indicates the engaged gear

| | |
|---|----------------------|
| N | Neutral |
| R | Reverse |
| 1 | 1 st gear |
| 2 | 2 nd gear |
| 3 | 3 rd gear |
| 4 | etc..... |

Launch Launch mode

Auto Automatic gearbox mode

Auto▼ Auto easy exit gearbox mode

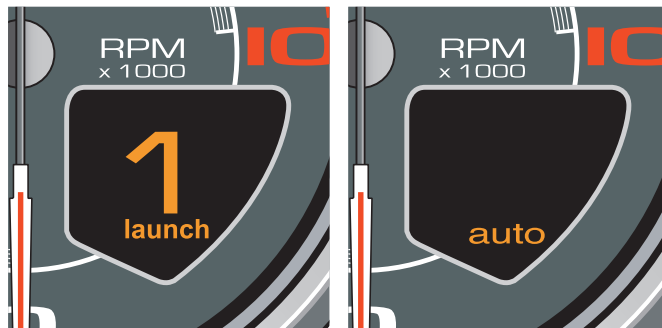

When the DCT gearbox is used in “manual” mode and gears are selected using the steering column stalks, the number indicating the engaged gear appears in the centre of the DOT MATRIX display.

When the DCT gearbox is used in “automatic” mode, the number indicating the engaged gear appears on the DOT MATRIX display: N (Neutral), R (Reverse).

At key-off if the panel receives the value N (Neutral), the letter N is displayed whereas if a gear is engaged, the letter P (Parking) is displayed.

“Auto” gearbox mode

When the DCT gearbox is used in “automatic” driving mode, the word “AUTO” number appears on the DOT MATRIX display as well as the engaged gear.

“Auto easy exit” gearbox signal

At each key-on, the “auto easy exit” signal is displayed.

A small arrow pointing downwards appears in fixed mode on the DOT MATRIX display.

“Launch” mode

When the Launch function is required, by pressing the correct button (see page 166), the word “LAUNCH” appears on the DOT MATRIX display until key-off or until the function is activated.

AVH system activated

When the AVH system is activated, the word “HOLD” appears on the DOT MATRIX display.

Roof panel controls

Deactivating the alarm system motion sensors.

Press button **H** to deactivate the anti-lifting alarm system.

Press button **H** again to activate the anti-lifting alarm system.

When this feature is deactivated, the LED on the button flashes for about 3 seconds and then turns off.



Controls on the steering wheel

Start button

Press the ENGINE START button **A** to start the engine. When the engine has started, release the ENGINE START button.

Do not hold the ENGINE START button down for a long time.

Driving mode control switch “Manettino”

The driving mode selected does not exempt the driver from complying with the rules of safe driving.

The driver can select the driving mode using the “Manettino” **B**, according to the desired driving style.

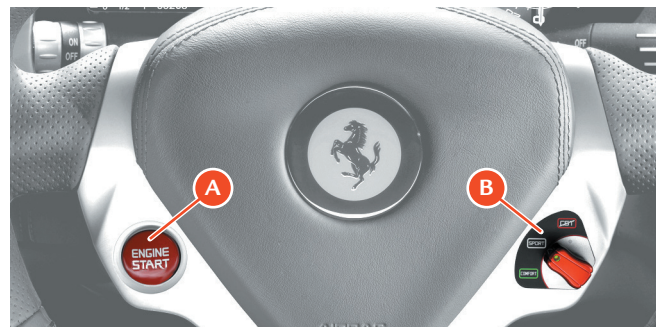

Important note



In the event of a failure of one of the onboard systems, signalled by the relative warning light on the TFT display, the switch moves to a “recovery” position, but still allows the vehicle to be driven. In these cases, contact the **FERRARI SERVICE NETWORK**.

Driving modes that can be selected with “Manettino”

COMFORT mode

This is the maximum safety driving mode. It is recommended for everyday driving.

SPORT mode

This is the ideal setting for vehicle performance.

Select **SPORT** mode for sports-style driving, under high-grip conditions.

Activation will be signalled by the **SPORT** icon in the dedicated area on the TFT display.

CST-OFF mode

Select this mode to deactivate the CST system (always active when the engine is started).

When the system is deactivated, the relative warning light **A** illuminates on the instrument panel and the relative ASR/CST failure warning light will be shown on the TFT display for 5 seconds.

When the CST feature is active, the warning light **A** starts flashing on the instrument panel and the relative warning light on the TFT display illuminates.

Important note



In low- to medium-grip conditions (e.g. wet, icy, sandy roads), do not deactivate the CST system.

When the CST system is active and the amber warning light comes on, it means that there is a fault in one of the CST system components.

Important note



Every time the engine is started, the CST system will reactivate.

Important note



The CST system reactivates automatically, even in even in CST mode when the brake pedal is pressed.

Horn control

The horn can be used by pressing the horn symbol, on either side of the steering wheel upper spokes.

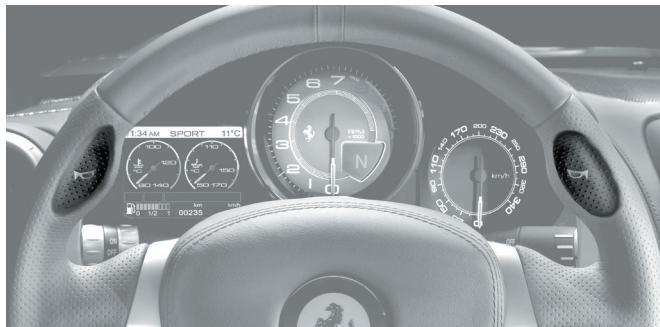

“UP” shift paddle

Pull the right-hand **UP** paddle towards the steering wheel to shift gears up.

“DOWN” shift paddle

Pull the left-hand **DOWN** paddle towards the steering wheel to shift gears down.



Windscreen and headlight washer/wipers

Important note



The windscreen wipers and washer work only with the ignition key in position II.

The lever **A** has 5 settings:

- OFF** Windscreen wipers stationary.
- AUTO** Automatic operating. In this position, the rain sensor's sensing range can be adjusted (lever pushed down to first click position).
- 1** Slow continuous operation (lever pushed down to second click position).
- 2** Fast continuous operation (lever pushed down to third click position).
- Lever up** Fast temporary operation (automatic return).

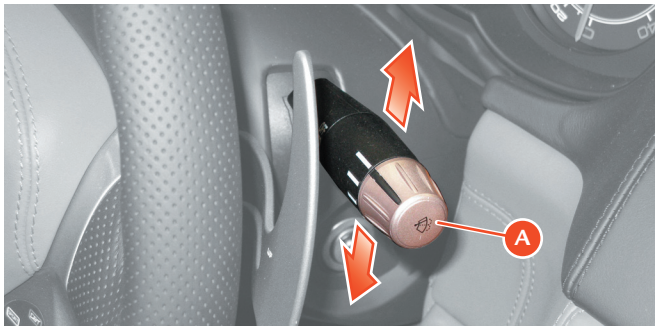

Windscreen washer

This is activated by pulling lever **A** towards the steering wheel (automatic return).

When the windscreen washer is activated, the windscreen wiper starts automatically.

Releasing the lever stops the jet of fluid while the blades continue to wipe for a short time.

Warning



Do not start the windscreen washer during the cold months until the windscreen has warmed up. If it has not warmed up, the fluid could freeze on the glass and block the view.

Headlight washer (optional)

The headlight washer is activated automatically when the windscreen washer is operated and the low beams are on.

The headlight washer and windscreen washer share the same fluid tank and a low fluid level is indicated by the relative warning light on the TFT display.

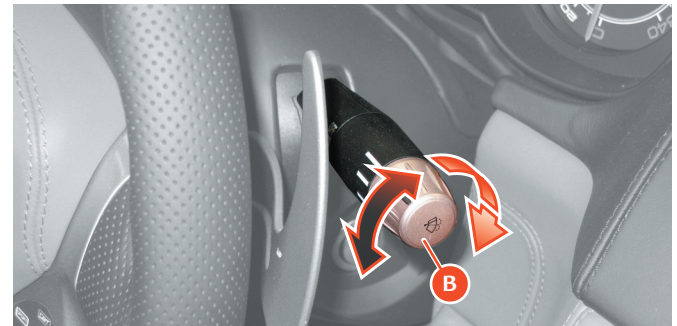

Cruise control

This is an electronically controlled driving assistant that allows the driver to drive the vehicle at a constant speed from 30 km/h - 200 km/h without keeping the accelerator pedal pressed.

Important note



We recommend using the device on long, dry stretches of road with few gear changes (e.g. motorways).
Do not use the device for city driving.

Activating the device

Turn the ring nut **A** to the **ON** position.

When it is activated, warning light **D** comes on on the instrument panel and a warning light and associated message appears on the TFT display.

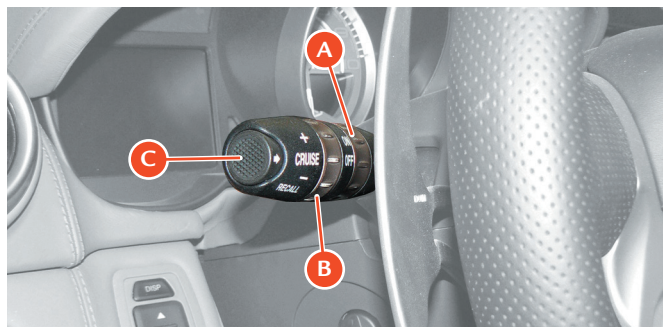

The device can only be activated in 4th or 5th gear. When going down slopes with the device on, the vehicle speed may increase slightly more than the memorised speed.

Memorising vehicle speed

Proceed as follows:

- turn the ring nut **A** to **ON** and bring the vehicle to the desired speed by pressing the accelerator pedal
- turn the ring nut **B** upwards (+) for at least three seconds, then release it: the vehicle speed will be memorised and you can release the accelerator pedal

If necessary, you can accelerate by pressing the accelerator pedal: when the pedal is released, the vehicle will return to the speed already memorised.

Resetting the memorised speed

If the device has been turned off by pressing the brake pedal or clutch, for example, to reset the memorised speed, proceed as follows:

- gradually accelerate until the vehicle reaches a speed that is near to the memorised speed
- insert the gear selected when the speed was memorised (4th or 5th gear) and press the Recall button **C**.

Increasing the memorised speed

This can be done in two ways:

- by pressing the accelerator and memorising the new speed reached
- or
- turning the ring nut **B** upwards (+).

Each time the ring nut is turned corresponds to an increase in speed of approximately 2 km/h whereas if the ring nut is kept up the speed varies continuously.

Reducing the memorised speed

This can be done in two ways:

- by deactivating the device and then memorising the new speed or
- by turning the ring nut **B** downwards (-) until it reaches the new speed that will be automatically memorised.

Each time the ring nut is turned corresponds to a decrease in speed of approximately 2 km/h whereas if the ring nut is kept down the speed varies continuously.

Deactivating the device

Turn the ring nut **A** to **OFF** or the ignition key to position **0**. The device is then automatically deactivated in one of the following ways:

- by pressing the brake pedal or the clutch.

Warning



When driving with the device activated, do not put the shift paddle in neutral.

Warning



If the device is malfunctioning or faulty, turn the ring nut to **OFF** and contact the **FERRARI SERVICE NETWORK**.

Rain sensor

The rain sensor automatically adjusts the windscreen wiper timing to the intensity of the rain during intermittent operation.

All functions controlled by the right-hand lever are unaffected.

The rain sensor automatically activates when the right-hand lever is moved to **AUTO** and it has a range of adjustment which runs from “wiper stationary” (when the windscreen is dry) to “fast continuous operation” (with heavy rain).

To regulate the frequency of intermittent operation, with the lever set to **AUTO**, turn the control **C**.

Turning the end knob counterclockwise, intermittent operation varies from a maximum (fast intermittent operation) to a minimum (slow intermittent operation).

Important note



The rain sensor function is reset by turning the ignition key to position **0** and also by leaving the right-hand lever in position **AUTO**. To reactivate it, turn the control to **OFF** and then again to **AUTO**.

Warning



Before cleaning the front windscreen (for example in service stations) make sure the rain sensor is deactivated or that the key is at position 0. The rain sensor must be deactivated also when washing the vehicle by hand or in automatic car washes.

In case of ice or snow on the front windscreen, do not activate the rain sensor to avoid damaging the wiper motor and/or blades.

Rain sensor failure

In the event of a malfunction occurring when the rain sensor is active, the wipers will be set to intermittent operation and the sensing range will be set by the driver, whether there is rain on the windscreen or not. In this case, we recommend that you deactivate the rain sensor and turn on the wipers, if necessary, in continuous mode.

Important note



Contact the FERRARI SERVICE NETWORK as soon as possible.

Driving the vehicle

Running-in

The latest manufacturing techniques have allowed us to achieve high precision and accuracy levels in the construction and assembly of components. Nonetheless, the vehicle movable parts undergo a settling process, basically during the first hours of operation.

Engine and transmission

Avoid exceeding 5,000 RPM for the first 1,000 km (620 mi.).

After starting, do not exceed 4,000 RPM until the engine has warmed up (oil temperature: 65-70 °C - (149-158 °F)).

Do not let the engine run at a constantly high speed for a prolonged time.

Warning



BEFORE YOU DRIVE

Check that the seat belts are fastened

Check that the doors are closed

Check that the seat is properly adjusted

Check the rear-view mirror adjustment (central and sides).

Before a trip

Preliminary checks

Check the following at regular intervals and always before long trips:

- tyre pressure and condition
- levels of fluids and lubricants
- condition of the windscreen wiper blades
- proper functioning of the warning lights and external lights.

Important note



In any case, it is advisable to perform these checks at least every 1000 km (620 mi.) and always comply with the maintenance schedule.

It is also advisable to:

- clean the glass covers of the external lights and all the glass surfaces
- properly adjust the mirrors, steering wheel, seats and seat belts.

Refilling

Warning



Use unleaded fuel only!

Using leaded fuel would permanently damage the catalytic converters.

For specifications and quantities of lubricants and fluids, observe the information in the “Refilling” table.

Starting and driving the vehicle (DCT gearbox)

System start-up

When the ignition key is turned to position II, the DOT MATRIX gearbox display and failure warning light **A** are turned on. The warning light will turn off if no problems are detected within a few seconds.

The letter P (Parking) or N (Neutral) will remain highlighted on the display.

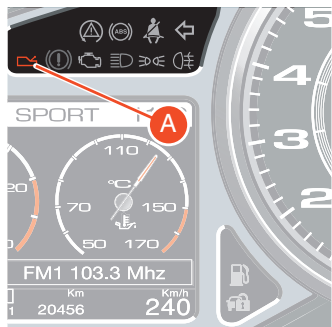

Important note



BEFORE YOU DRIVE

If the warning light **A** continues flashing without going off, switch off the system and wait for the gear display to go off before restarting.

If the failure persists, contact the Ferrari Service Network.

If the warning light **A** is faulty, a warning light will appear on the TFT display (see page 143) and this condition will be indicated by an acoustic alarm when the ignition key is turned to position II.

Warning



Contact the FERRARI SERVICE NETWORK.

Operation with the engine off

Important note



The vehicle is equipped with an electro-hydraulically controlled gearbox system by means of paddles on the steering wheel.

The default setting for the DCT gearbox is always “Automatic” mode.

Every time the vehicle is started, the DCT gearbox is in “Auto easy exit” mode unless the vehicle was in “Automatic” mode when it was turned off.

To exit the “Auto easy exit” mode operate the **UP** or **DOWN** paddle (while the vehicle is moving) or press the **AUTO** button on the central console.



Once the “**System start-up**” stage has been completed, the engaged gear will appear on the DOT MATRIX display:

N (Neutral)

P (Parking);

R (Reverse);

1 (1st gear);

2 (2nd gear), etc.

Important note



Immediately release the **UP** and **DOWN** paddles and the button **R** after the display shows that the gear has been engaged; a prolonged manoeuvre would cause the failure warning light to turn on (see page 143) and triggering of the buzzer.

Important note



If the engine compartment lid is open or not properly closed, none of the gears can be engaged. When the vehicle is stationary, with the driver-side door open or not properly closed and the brake pedal released, the system disengages the gear engaged after approximately two seconds.

Starting the engine

Before starting the engine, make sure that the anti-theft system and the electrical devices that absorb a great deal of power are deactivated.

- Make sure that the electric parking brake is applied and that the doors are closed.
- Hold the brake pedal down when starting the engine.

Warning



Do not press the accelerator pedal.

- Turn the ignition key to position **II** and wait for the “**Check OK**” icon to appear on the TFT display.
- If the “**Check OK**” symbol does not appear, turn the key back to position **0**, wait a few seconds and repeat the procedure.
- Press the **ENGINE START** button (see page 146) and release it as soon as the engine starts.
- After the engine has started, the “**Check OK**” will appear.

Do not hold the **ENGINE START** button pressed down for a long time.

If the engine does not start, turn the key back to position **0** and wait for the gear display to go off before retrying.

Warning



Hold the brake pedal down while starting the engine.

If the engine does not start, turn the key back to position **0** and wait for the gear display to go off before repeating the whole operation.

If the engine fails to start after several attempts, check for one of the following causes:

- insufficient speed of the starter motor (flat battery)
- ignition device faulty
- electrical contacts faulty
- fuel pump fuses blown.

Warming up the engine

Do not run the engine at high speeds until the engine oil temperature has reached at least 65-70 °C (149-158 °F), approximately.

Starting the vehicle

With the engine started, the vehicle standing and the brake pedal pushed, pull the right-hand “**UP**” paddle towards the steering wheel to engage the **1st** gear.

Release the brake pedal and press the accelerator to start off.

With the engine running and the vehicle stationary, you can change directly from **1st** or **2nd** gear to “**R**” (reverse) by pressing **R** and from reverse to **1st** by moving the “**UP**” paddle.

Warning



If the “**UP**” and “**DOWN**” paddles are not working, the message “Depress brake pedal and press **LAUNCH** to engage gear” will appear on the TFT display. You can therefore engage the gear by pressing the **Launch** button (see page 166) and the brake pedal. In these cases, the **Launch** control function is not available.

If the engaged gear was **R**, the **Launch** button must be pressed twice to engage the **1st** gear.

Important note



When reverse is selected, an acoustic safety signal beeps intermittently as long as “R” is engaged.

If the system automatically selects 2nd gear when attempting to shift from R to 1st gear, this indicates that 1st gear has jammed. Therefore, this is not a malfunction, as it falls within the system operation logic. For the same reason, when shifting from 1st gear to “R”, the system will automatically engage “N” if the gear has jammed.

During prolonged stops with the engine running, it is advisable to keep the gearshift in “N”.

Important note



On downhill stretches, if you allow the vehicle to move forward in N, when UP or DOWN is requested, a gear will be engaged that corresponds to the speed of the vehicle.



UP-shifting

Use the right-hand “UP” paddle without releasing the accelerator pedal.

An **UP-shift** request is not accepted when engagement of the requested gear forces the engine to underrev or if an **UP-shift** is already in progress due to engine overrevving.

Gearshifting will be much quicker if the request is made with the accelerator pedal pushed right down and the engine at over 5,500 rpm.

In any event, it is advisable to:

- Gearshift without releasing the accelerator pedal if pressed.
- Wait until gearshifting has been completed before requesting the next shift, avoiding a rapid sequence of multiple requests.

UP-shifting due to overrevving

The system “**automatically**” engages a higher gear if the accelerator pedal is pressed and the engine approaches the “**runaway speed rate**” (overrevving).

Important note



This condition does not occur with the system in “SPORT” mode.

DOWN-shifting

Use the left-hand “**DOWN**” paddle, even without releasing the accelerator pedal.

A **DOWN-shift** request is not accepted if engagement of the requested gear forces the engine beyond a certain number of revolutions, depending on the gear requested, or if a **DOWN-shift** is already in progress because of underrevving.

In any event, it is advisable to:

- Gearshift without releasing the accelerator pedal if pressed.
- If “**DOWN-shifting**” is requested to start overtaking which requires quick acceleration, press the accelerator pedal just before using the paddle.
- Wait until gearshifting has been completed before requesting the next shift, avoiding a rapid sequence of multiple requests.

“*DOWN-shifting due to underrevving*”

- The system down shifts “**automatically**” if the engine goes below a minimum number of revs of 1250 rpm.
- The **DOWN-shift** request from the paddle ignored if gearshifting is already in progress because of underrevving.

“N” (Neutral) request

If necessary, “N” can be requested at any speed.

Subsequently, if an “**UP**” or “**DOWN**” shift is requested, the system will engage the gear most suited to the speed of the vehicle.

Switching off the engine

The engine can be switched off either with the gearbox in “N” or with a gear engaged.

After turning the ignition key from position **II** to position **0**, the display will remain on for a few more seconds to display the gear engaged. If the gearbox is in “N” a buzzer will sound.

Warning



Never leave the vehicle with the gearbox in “N”. Make sure that the letter “P” appears on the display.

Warning



Never leave the vehicle with the engine running.

Important note



If the vehicle is not in Parking mode (“P” must be displayed on the DOT MATRIX display), the key cannot be removed.

For information on the electronic parking brake, see page 167.

“Automatic gearbox” mode

This mode is activated (or deactivated) using the **AUTO** switch; the word **“AUTO”** will light up on the gear display and the system will automatically adjust **UP-shifting** and **DOWN-shifting** according to the vehicle speed, engine speed and torque/power request of the driver.

Gearshifting is possible using the **“UP”** and **“DOWN”** paddles but the system remains in **“Automatic”** mode.

To exit the **“Automatic”** mode, you must press the **AUTO** switch until the **“Automatic”** warning light goes out.

When the vehicle stops, the request for **“N”**, **1st** or **“R”** does not change the mode from **“Automatic”** to **“Normal”**.



“Auto easy exit” gearbox mode

The vehicle is always started in **“Auto easy exit”** mode, unless it was turned off with the gearbox in **“Automatic”** mode.

Activation is indicated by the word **AUTO ▼** on the gear display on the instrument panel.

The system will automatically UP-shift and DOWN-shift according to vehicle speed, engine revs and the torque/power request of the driver.

In **“Auto easy exit”** mode, if you operate the **UP** and **DOWN** paddles (while the vehicle is moving) the system will exit the **“Automatic”** mode and go into **“Manual”** mode.

If the **“Automatic”** gearbox mode is then requested by pressing the **AUTO** button, the system will apply all the characteristics of the **“Automatic”** gearbox mode.

Push start

Warning



Push starting is not allowed.

Safe driving

For safe driving, it is essential that the driver be aware of the best driving techniques suited to various circumstances. Always try to prevent dangerous situations by driving with caution.

Before you drive

- Adjust the position of the seat, steering wheel and rear-view mirrors, in order to obtain the best driving position.
- Adjust the backrest so that your chest is upright and your head is as close to the headrest as possible.
- Carefully adjust the headrest so that your head, and not the neck, is resting against it. Ensure that nothing (e.g. mat covers, etc.) is blocking the pedals.
- Check that the lights and headlights are working properly.
- Ensure that any child restraint systems (e.g. child seats, cradles etc.) are properly fixed on the passenger seat.
- Your reflexes are quicker if you eat lightly before driving: avoid heavy meals before a trip.
- Do not drink alcoholic drinks before and during the journey.

At regular intervals, check the following:

- Tyre pressure and condition
- Engine oil level
- Engine coolant level and system condition
- Brake fluid level
- Steering fluid level
- Windscreen washer fluid level.

While travelling

- Caution is the number one rule for safe driving, which also means you should take other people's behaviour into consideration.
- Follow the Road Regulations in force in the country you are driving in and always respect the speed limit.
- Always make sure that the driver and the passenger have their seat belts fastened and that all children are travelling in suitable child seats.
- Good personal physical conditions ensure you can drive long distances safely.

Warning



Driving under the influence of drugs or certain medications is dangerous to yourself and others as well as contravening road regulations and legal norms.

Travelling without your seat belt fastened increases the risk of serious injury and death in the event of a collision. Always fasten the seat belt and the child seat, if any.

Deactivate the passenger's airbag (where possible) if a child seat is fitted on the front seat.

Do not travel with objects lying around on the floor, especially in front of the driver's seat: in the event of braking, these could slide under the pedals, making it impossible to brake or accelerate.

Additionally, ensure that any loose floor mats sit correctly.

Water, ice and salt spread on icy roads may deposit on the brake discs and reduce the efficiency of the initial braking.

- Make regular stops to loosen up your limbs and refresh yourself and avoid driving for hours on end.
- Keep a constant air circulation in the passenger compartment.
- Never coast downhill with the engine off: in these conditions the engine brake, servo brake and power steering are inefficient, braking requires greater pressure on the pedal and steering will be harder.

Driving at night

When you are travelling at night, follow these fundamental rules:

- Reduce speed, particularly on dark roads.
- Driving conditions are more demanding at night, so take particular care.
- If you start feeling tired or sleepy, stop immediately: to continue driving would be a risk for yourself and for others. Continue only after you have had a rest.
- At night, it is difficult to evaluate the speed of the vehicles in front of you by seeing their lights only: keep at a greater safety distance than you would during the day.
- Use the high beams only outside of urban areas and when you are sure that they will not disturb other drivers.
- Turn off the high beams when you see oncoming vehicles and use the low beams.
- Keep the lights and headlights clean.
- Watch out for animals crossing the road when travelling outside urban areas.

Driving in the rain

Rain and wet roads can cause hazardous situations.

All manoeuvres are more difficult on a wet road, as the tyres have significantly less grip on the road. This means that the braking distances increase considerably and road-holding decreases.

Below is some advice for driving in the rain:

- Keep a greater safety distance between yourself and the other vehicles and reduce your speed.

- When it is raining very hard, visibility is also reduced. In these cases, to make yourself more visible to others, turn on the low beams even during the day.
- Do not drive through puddles at high speeds since you do not know how deep they may be; Travelling through a puddle at high speed can result in losing control of the vehicle (“aquaplaning”): if this occurs, grip the steering wheel firmly.

Warning



If the road is wet, reduce your speed to avoid “aquaplaning” (during which the tyre no longer touches the road surface. This is due to the fact that, when the road is very wet and vehicle speed is high, because of their particular shape or insufficient depth, the side channels of the tyre tread are not capable of removing all of the water channelled so that a layer of water is placed between the road surface and the tyre. The fluid pressure generated is so high that it supports the vehicle's weight making it virtually impossible for the driver to control the vehicle).

- Use the ventilation system to demist the windscreen (see page 174) and avoid visibility problems.
- Periodically check the condition of the windscreen wiper blades.

Driving in fog

Whenever possible, avoid setting off if the fog is thick. If you have to drive in misty conditions, or if there is thick fog or fog banks, follow these rules:

- Keep a moderate speed.
- Turn on the low beams, also during the day, and use the rear fog light. Avoid using the high beams.

Warning



On stretches where visibility is good, turn off the rear fog light, it may be annoying for the occupants of the vehicles behind you.

- Remember that fog makes the road damp and therefore all manoeuvres are more difficult and braking distances are longer.
- Keep a safe distance from the vehicle in front of you.
- As far as possible, avoid suddenly changing speed and direction.
- As far as possible, avoid overtaking.
- In the event of an emergency stop, (e.g. failures, inability to proceed due to poor visibility conditions, etc.) try to free the main driving lane. Then turn on the hazard warning lights and, if possible, the low beams. On approaching another vehicle, sound the horn rhythmically.

Driving on mountain roads

Below is some advice for driving on steep mountain roads:

- To prevent the brakes from overheating when driving downhill, use the engine to brake by engaging a lower gear.
- Never coast downhill or drive downhill with the engine off or in neutral, nor with the ignition key removed from the steering column.
- Drive at a moderate speeds and do not “cut” corners.
- Remember that overtaking uphill is slower and requires a longer free stretch of road. If you are overtaken when driving uphill, ensure that the other vehicle can pass easily.

Driving on snowy or icy roads

Below is some advice for driving in these conditions:

- Keep a very moderate speed.
- Keep a safe distance from the vehicles in front of you.
- Fit snow tyres approved for the vehicle.
- Given the poor grip, use the engine brake as much as possible and avoid sudden braking.
- Avoid sudden acceleration and sharp changes in direction.
- During the winter season, even apparently dry roads can have icy sections.

Therefore, be careful when driving along stretches of road in the shade as there may be icy patches.

Driving with the “ABS” braking system

The ABS system assists the driver as follows:

- It prevents the wheels from locking and skidding during emergency braking, particularly in low-grip conditions.
- It allows braking and changing direction at the same time. This feature is affected by the physical limits and lateral grip of the tyres.
- When the ABS is activated, you will feel a slight pulsing of the brake pedal during emergency braking or in low-grip conditions. Do not release the pedal but continue to push it to give continuity to the braking action.
- The ABS prevents the wheels from locking, but it does not increase the physical limits of grip between the tyres and the road: keep a safe distance from the vehicles ahead and reduce speed before curves.

Driving using the driving mode control switch (“Manettino”)

The driving mode control switch **A** on the steering wheel, allows the driver to use the vehicle potential in a quick and easy way.

There are three modes available which can be selected according to the grip level (from low to high) and consequently the level of driving assistance required (from high to none).

- The **COMFORT** mode is for driving in maximum safety in all conditions and particularly in low grip situations. It is recommended for everyday driving.

If the COMFORT mode is selected, it is indicated on the TFT display as follows:

- The **SPORT** mode is the vehicle driving mode that provides the best compromise between stability and performance. This setting ensures stability only in medium- to high-grip conditions and not on low-grip road surfaces (in this case, it is advisable to return to **Low Grip** mode). In this mode, the vehicle maximum performance can be experienced on open roads.

For this reason, the suspension damping level is shifted to a higher one, so as to enhance performance, handling and stability at high speeds.

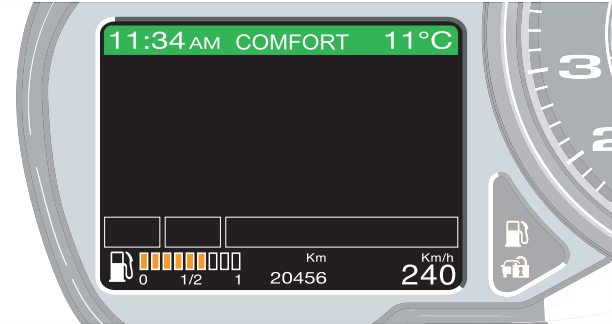

If the SPORT mode is selected, it is indicated on the TFT display as follows:

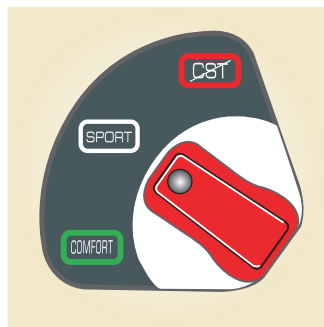
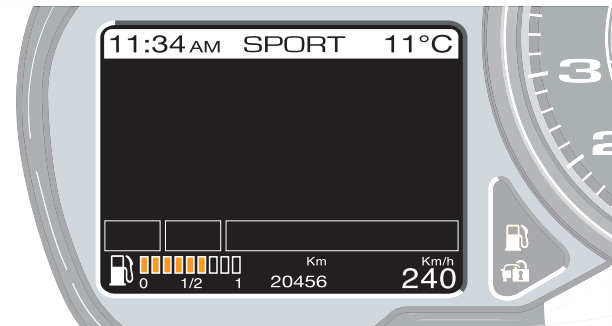

- The CST is deactivated. Vehicle stability is no longer controlled, but is completely in the hands of the driver. The only auxiliary systems still active are those that cannot be deactivated such as ABS and EBD.

If the CST mode is deactivated, it is indicated on the TFT display as follows:

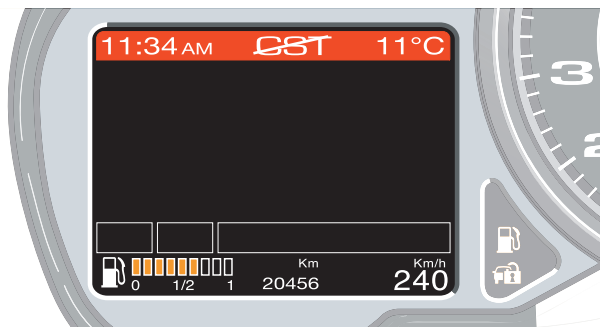

Carwash procedure

The Park lock emergency device can be electronically deactivated on a temporary basis by performing the Carwash procedure.

This procedure is necessary when the vehicle has to be moved with the engine off and when washing the vehicle.

Warning



When the Park Lock safety device is electronically disabled (Carwash procedure), the vehicle may move unexpectedly! The vehicle is only kept stationary by the parking brake which must be applied.

- With the engine running, select the first gear
- Select neutral “N”
- Switch off the engine
- Turn the key to key-on 3 seconds after switching off
- The message “Carwash mode activation” will appear on the TFT display.

Park Lock

The Park Lock is a locking device built into the gearbox.

This device is used to prevent the vehicle moving when the multi-disc clutches are open, i.e., with the engine off and/or without the hydraulic pressure needed for the gearbox.

This device operates automatically at each key off and “P” appears on the DOT MATRIX display.

If there is a system failure, refer to “Emergency unlocking of Park Lock” on page 214.

Ignition switch

The ignition key can be turned to 2 positions:

Position 0 - Stop

Engine off, key removable.

When the key is even only partially extracted, the steering column is locked.

The hazard warning lights and the parking lights can be activated.

To facilitate steering wheel release, turn the steering wheel slightly in both directions while turning the ignition key.

Position II - Ignition

Turning the key to this position, the TFT display will check the signals coming from the vehicle systems.

If no malfunctions are found after starting up, the words “**Check OK**” will be displayed.

Warning



Always remove the key from the ignition when you get out of the vehicle!

Never leave children unattended in the vehicle.

Key lock

If more than 20 seconds elapse after turning the key to position 0, the key lock device must be released to remove the key: press button **K** and remove the key at the same time.

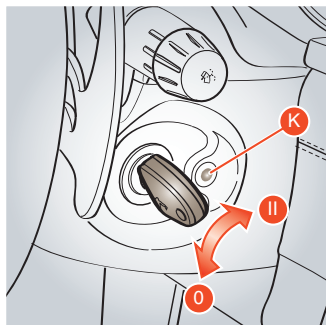

Launch

The “Launch” mode is a performance start function. Activating this function gives the vehicle the best possible acceleration.

The device transfers the necessary torque to the ground and avoids skidding of the wheels during acceleration.

The “Launch” mode is activated as described below:

- the vehicle must be stationary
- gearbox must be in manual mode
- select the first gear
- press button **L** to the left of the centre console
- press the accelerator pedal and release the brake pedal.

Important note



The Launch control function is not available in presence of:

- a sloping road surface, even slight
- high clutch temperatures.



EPB - Electronic parking brake

The parking brake is controlled by a small electric engine.

It can be applied and released using the special control **A** on the dashboard to the left of the steering wheel.

The brake is automatically activated when the engine is switched off and can be temporarily deactivated by pressing button **B**.

Pushing down the brake pedal and pressing button **A** deactivates it automatically.

The electric parking brake can operate as an emergency brake when the vehicle is in motion.

If this is the case, the electric parking brake communicates with the ESP system to prevent locking. The warning light will turn off when the parking brake is fully released.

Warning



Always apply the parking brake when the vehicle is parked.
The vehicle should be blocked. If this is not the case, please contact the FERRARI SERVICE NETWORK.

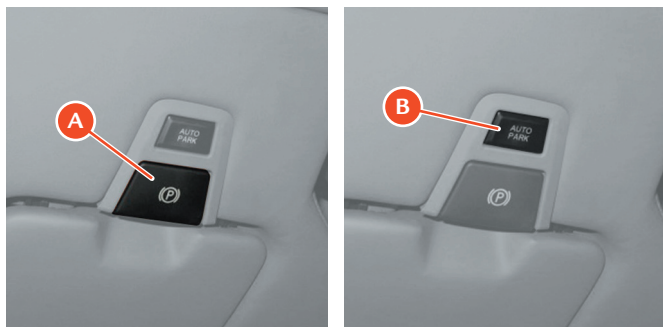

Seat adjustment

Warning



Never adjust the seat while driving; you may lose control of the vehicle. Adjust the driver's seat only when the vehicle is stationary.

Correct adjustments are very important for a better driving comfort and for the maximum efficiency of the passive safety systems.

The seat position can be electrically adjusted using the special controls.

Three adjustments are possible using control **D**:

- forward/backward adjustment: push the control forward or backward
- height adjustment: push the control upward or downward
- seat inclination (tilting): push the front end of the control upward or downward to adjust the inclination of the front part of the seat cushion; push the rear end of the control upward or downward to adjust the inclination of the rear part of the seat cushion.

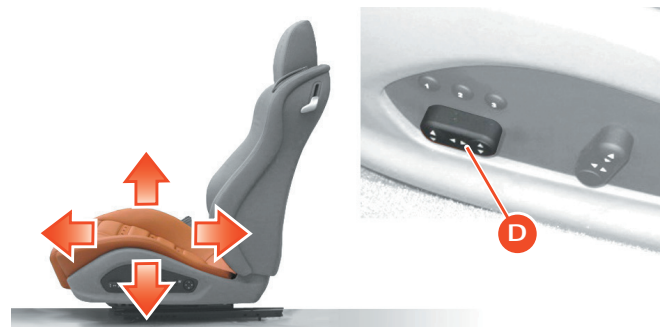

Seat back rake adjustment

Use control **E** to adjust the seat back rake. Push the control forward or backward to adjust the seat back rake.

Lumbar support adjustment (Full Electric option)

Use control **F** to adjust the lumbar support. Push the control on the seat symbols to increase or decrease the lumbar support.

Backrest and cushion side width adjustment (Full Electric option)

Use control **G** to pneumatically adjust the width of the backrest sides and the seat cushion. Push the control on the seat symbols to increase or decrease the side width.



Seat position memory (2+2 version and Full Electric option)

When a front door is open at key-off (key in position 0), the seat can be moved for a limited period (approx. 15 sec.). Each time a door is opened or both doors are closed at key-off, the seat can be moved again for a limited period.

The seat position can only be memorised at key-on (key in position **II**), by pressing one of the three buttons 1, 2 or 3 (**H**) each corresponding to a memorisable position. Pressing one of these buttons for longer than 3 seconds memorises the position of the driver seat, rear-view mirror and steering column (confirmed by emission of a double tone).

To recall the memorised position, press one of the buttons **H** and release it within 3 sec. Operating begins as soon as the button is released.

Recalling the memorised position is not allowed when the vehicle is in motion. If the vehicle starts to move while the memory recall is being operated, the seat and column do not stop moving and reach the memorised position.

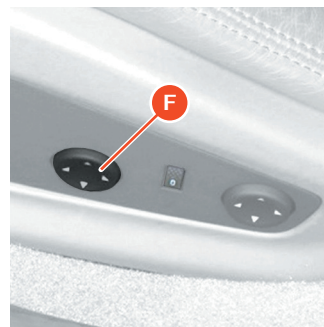

If the memorised backward/forward position of the passenger seat is less than approximately 50 mm from the rear stop, when the seat position is recalled from another backward/forward adjustment, the seat stops once it is approximately 50 mm from the rear stop. The position can be adjusted by using the backward/forward adjustment control.

With reverse gear engaged, the position of the passenger external rear-view mirror can be adjusted by the user to a position other than the driving position to help when parking. This position can be memorised along with all the other memorisable positions.

If the personalised reverse gear position is never set, when the reverse gear is engaged, the passenger external rear-view mirror will be positioned slightly downwards and inwards (compared with the driving position).

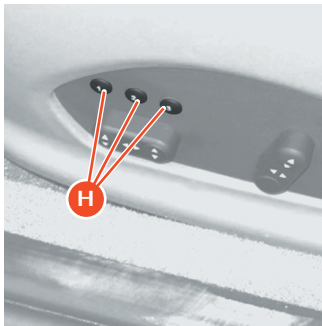

Tilting the backrest

To tilt the seat, pull lever **L** up and push the backrest towards the front of the vehicle.

When the backrest goes back into position, it will automatically block once it has reached the correct position.

To facilitate access to the rear seats or exiting the vehicle, the front seats are equipped with the “rear seat Easy Entry” device (only operative when doors are open or vehicle is stationary), which moves the seats forward to the front stop and lowers them automatically when the relative backrests are lowered and returns them to the original position when the backrests are lifted again.

If the initial backward/forward position of the passenger seat is less than approximately 50 mm from the rear stop, during the return the seat will stop at 50 mm from the rear stop. The position can be adjusted by using the backward/forward adjustment control.

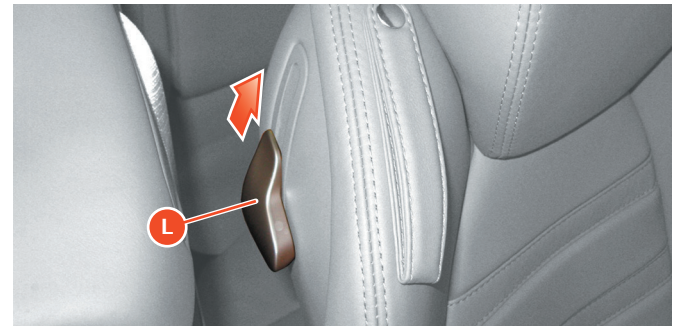

Headrest adjustment

Place the headrest at a height that corresponds to the height of the occupant. To raise the headrest, simply pull it up.

To lower the headrest, press button **M**.

Seat heating system (Full Electric option)

Turn control **N** to activate the seat heating function.

When this function is active for one or more seats, the relative warning light on the instrument panel illuminates. Using control **N**, the driver can adjust the heating, choosing from 3 levels identified on the control with the numbers 1, 2 and 3. In position 0, seat heating is not activated.

Driver seat Easy Entry/Exit (2+2 version and Full Electric option)

To help the driver to get in and out of the vehicle, the driver seat Easy Entry/Exit function is activated (only operative when the door is open and the key is in position 0) which moves the steering wheel column upwards. When the door is closed and the key is in position **II**, the steering wheel column returns to its original position.

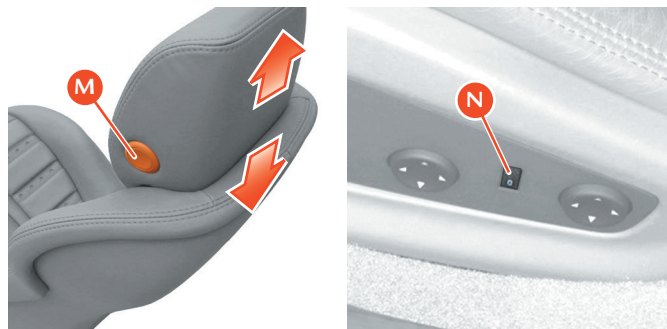

Adjusting the steering wheel

The steering wheel is electrically adjustable for rake and reach. It can only be adjusted if the ignition key is in position **II**.

Move control **A** (to the left of the steering column) in the four directions to adjust the steering wheel.

The steering wheel position is memorised, together with the position of the external rear-view mirrors, when the driver's seat position is stored.

Warning



Do not adjust the steering wheel while driving.

To help the driver when entering or exiting the vehicle, the steering wheel is lifted automatically.

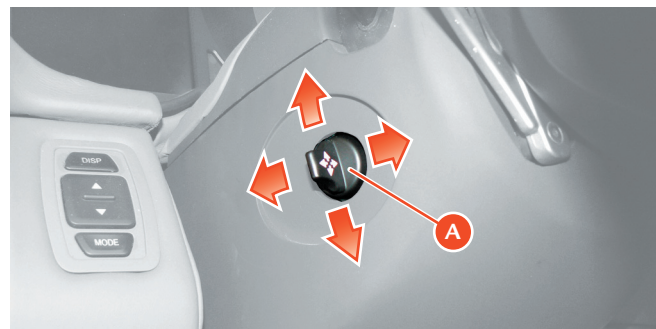

Rear-view mirrors

Internal electrochromic mirror

The internal electrochromic mirror automatically darkens to reduce the dazzling effect of the reflected light on the driver. The speed with which the mirror darkens depends on the intensity of the light.



External rear-view mirrors

These mirrors can be electrically adjusted using the control **C** (with the ignition key in position II) and are equipped with defogging elements.

- 1) Mirror selection: using control **C** select the mirror you wish to adjust (right- or left-hand).
- 2) Mirror positioning: move control **C** in the four directions (up – down – right – left) to adjust each of the rear-view mirrors.

Once adjustment is complete, move the control **C** into the upper central position, where it will be locked in order to avoid changing the setting inadvertently.

The mirrors will yield in both directions in the event of a collision: if necessary, the mirrors can be pushed both backwards and forwards.

In the models equipped with memory seats, every time the seat position is memorised, the external rear-view mirror position is also stored automatically, both for the normal travelling direction and for reverse manoeuvring.



To memorise a new position of the external rear-view mirrors, turn the ignition key to position II and adjust the position of the mirrors; then engage reverse and reposition the external mirrors to ensure the best possible visibility to perform the manoeuvre, then disengage reverse gear.

Finally, press one of the buttons 1, 2 or 3 on the seat (see page 168), each one corresponding to a memorisable position, until a double tone confirms the procedure is complete.

The new position of the external rear-view mirrors will be automatically memorised together with the seat position.

In addition, the mirror positions can be adjusted for both the normal travelling direction and for reverse manoeuvring.

The mirrors must always be in the open position while driving.

Air conditioning and heating system

Operating modes

Automatic

This mode automatically adjusts the air distribution, temperature and ventilation levels according to the temperature set by the user.

Partially Automatic

This mode allows the user to adjust certain parameters manually, while others remain automatic.

Manual

This mode allows the user to set the values to suit the passengers' needs.

Controls

- 1 Left-hand temperature setting and AUTO button
- 2 A.C. compressor activation/deactivation
- 3 Single-zone operating activation/deactivation
- 4 Air distribution fan speed
- 5 Rear screen demist activation/deactivation
- 6 Windscreen demist activation/deactivation
- 7 Right-hand temperature setting and AUTO button
- 8 Right-hand air distribution mode setting
- 9 Air recirculation
- 10 Left-hand air distribution mode setting

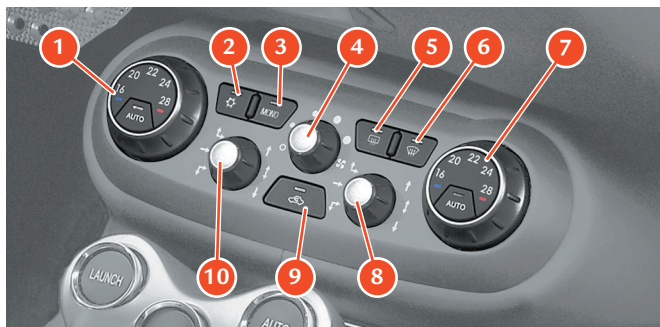

Left-hand temperature setting and AUTO button (1)

This is used to select the required air temperature in the left-hand side of the passenger compartment; the AUTO button is used to activate automatic operating (LED on).

A.C. compressor activation/deactivation (2)

This is used to activate (LED on) or deactivate (LED off) the A.C. compressor.

Single-zone operating activation/deactivation (3)

This is used to activate (LED on) or deactivate (LED off) single-zone operating.



Air distribution fan speed (4)

The four setting positions allow the occupants to select the air flow rate.

Rear screen demist activation/deactivation (5)

Press this switch (LED on) to activate rear screen defogging/demisting.

Windscreen demist activation/deactivation (6)

Press this switch (LED on) to activate windscreen defogging/demisting.

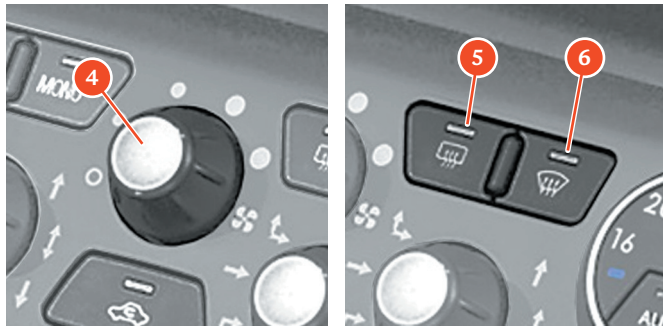

Right-hand temperature setting and AUTO button (7)

This is used to select the required air temperature in the right-hand side of the passenger compartment; the AUTO button is used to activate automatic operating (LED on).

Right-hand air distribution mode setting (8)

This is used to select one of the six air flow distribution modes in the right-hand side of the passenger compartment.

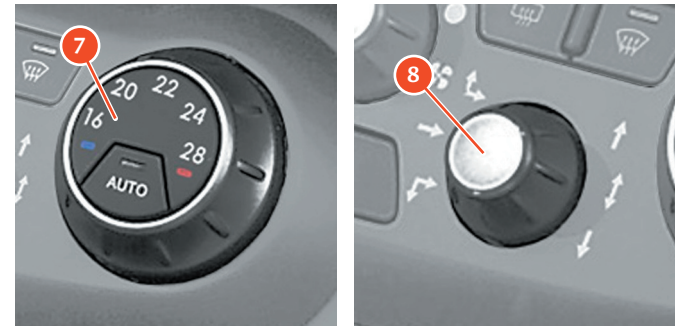

Air recirculation (9)

If released (LED off) ; the air flow comes from the outside.

When outside temperatures exceed 32 °C (90 °F), the air recirculation feature remains on with a 60-second pause every twenty minutes, to refresh the air.

If you activate the windscreen washer function, the air recirculation feature activates for 20 seconds, to prevent any smell of detergent products from entering the passenger compartment.

If pressed (LED on), the air flow comes from inside the passenger compartment.

The recirculation increases air heating or cooling.

Left-hand air distribution mode setting (10)

This is used to select one of the six air flow distribution modes in the left-hand side of the passenger compartment.

Once the internal temperature has stabilised at the desired level, you are advised not to change the position of the temperature selection switch unless the external temperature changes drastically.

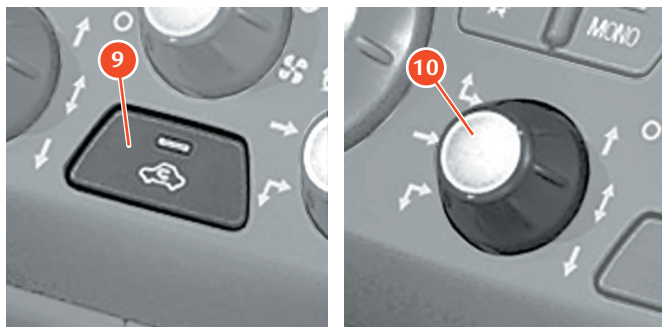

Important note



The air coming out of the vents does not correspond to the temperature requested by the user, but is the temperature required to maintain the desired temperature inside the passenger compartment.

Adjusting the air vents

The adjustable air vents are positioned on the sides and in the central section of the dashboard.

Directing the air flow **A**.

Air flow rate **B**.

Turned counterclockwise: open.

Turned clockwise: closed.

Important note



It is advisable to keep the air flow rate **B** set to open and to direct the air flow to a neutral position **A**.

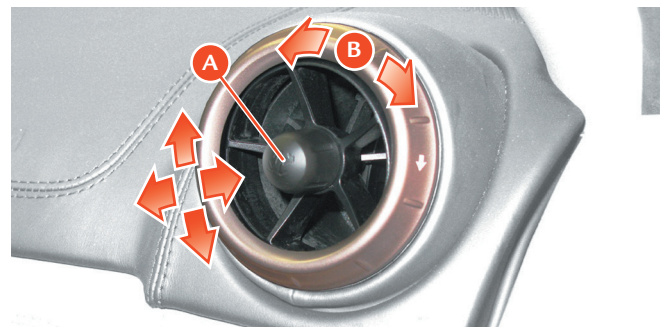

Maintenance

The pollen filter must be replaced every year, as indicated in the “Maintenance Schedule”.

Sun radiation sensor

This sensor is positioned on the dashboard and optimises ventilation and temperature control inside the passenger compartment depending on the incidence angle of the sun rays.

Passenger compartment accessories

Glove compartment

This is located on the passenger side of the dashboard. To open it, pull lever **C** and the glove compartment will move down slowly by way of a damped opening mechanism.

The glove compartment is illuminated by a light which turns on automatically when the door is opened.

Warning



Keep the glove compartment closed while driving.

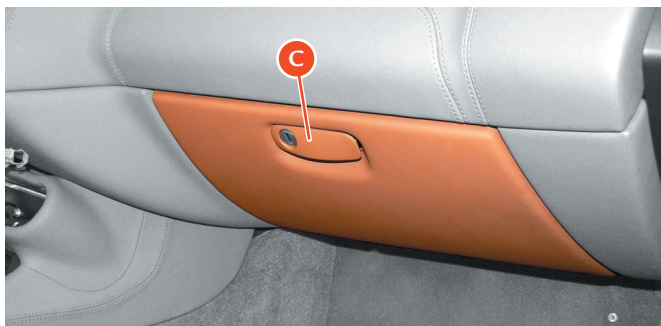

To close the glove compartment, push the top part until you hear the click of the lock.

Pocket-change compartments

They are located on the lower part of the doors and on the centre console.

Ashtray

To access the ashtray **G**, lift the lid back.

To clean the ashtray, remove it by pulling it up.

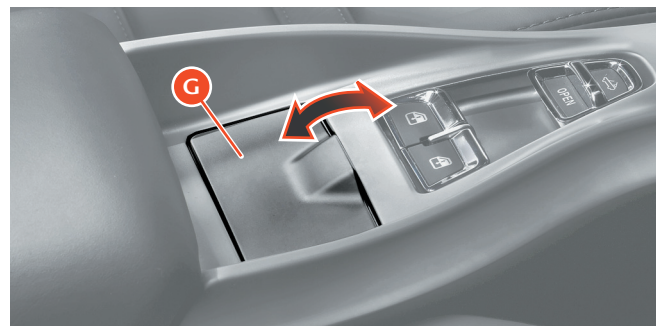

Sun visors

The sun visors can be moved by pulling them down towards the windscreen.

There is a mirror on the back of the passenger-side visor.

Flaps communicating with luggage compartment

To access the luggage compartment from the passenger compartment, open one or both rear flaps **F** and lower them onto the seats.



Placing suitcases in the luggage compartment

The luggage compartment secures the load in the luggage compartment and prevents the hard top from blocking when operated. Make sure you have closed the partition correctly so that it is blocked correctly both on the left and the right.

Warning



Do not place items above the partition: this is to avoid the risk of causing serious damage to the opening and closing mechanisms.

Warning



Do not place objects in the folded roof compartment: this is to avoid the risk of causing serious damage to the opening and closing mechanisms.



Warning



Do not place objects on or next to the partition between the luggage compartment and the folded roof compartment when closed. Do not place luggage above the level of the closed partition.

Important note



If possible, use the eyebolts to fasten the luggage with clamps or rope.

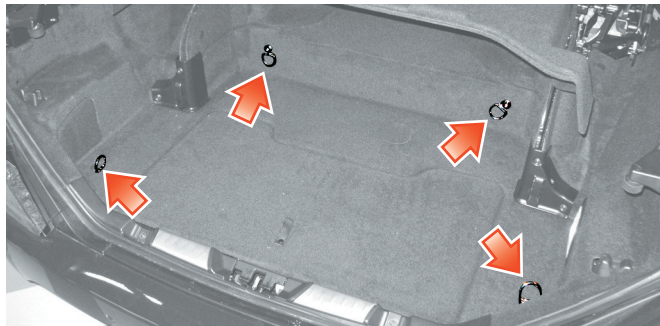

2 + 2-seater version

Warning



Place the light luggage as far down and as far forward as possible.

Place the heavy luggage in the lowest well of the luggage compartment as far forward as possible so that it touches the edge of the well. (Position **A**).

Do not place the luggage in unstable positions (Position **B**).

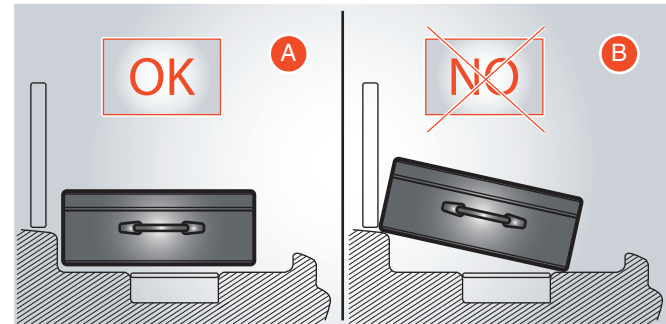

2-seater version

Warning



Place the light luggage as far down and as far forward as possible.

Place the heavy luggage in the lowest well of the luggage compartment as far forward as possible so that it touches the edge of the well. (Position **A**).

Do not place the luggage in unstable positions (Position **B**).

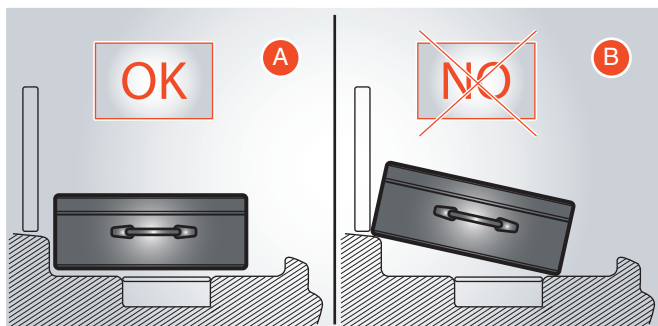

Warning



Rear shelf

Only place light luggage here and secure it using the special belts.



Wind deflector

The wind deflector can be used when driving with the retractable hard top open. It reduces wind buffeting in the passenger compartment and offers even more pleasant trips at higher speeds too.

The deflector is stored in a special bag in the luggage compartment.

Fitting

The deflector is divided into two parts: **A** and **B**.

- Take part **A** and open it as shown in the figure

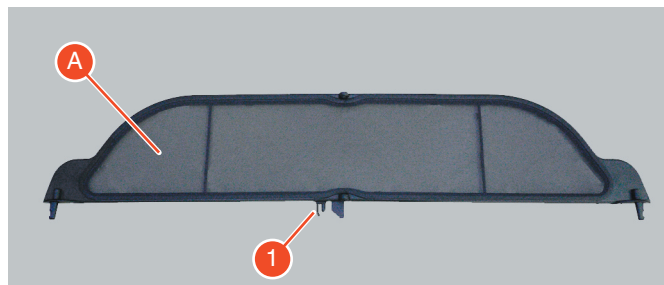

- Take part **B** and open it as shown in the figure

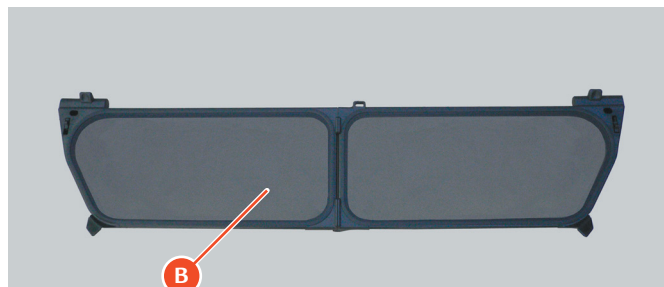

- Fit part **A** onto part **B** as shown in the figure.

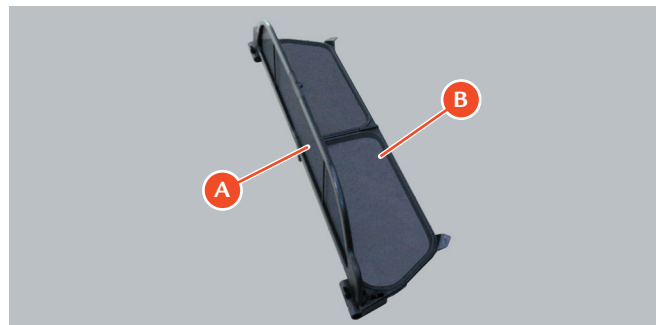

Important note



Make sure that the hook **1** has been correctly inserted.
Lock the fastenings **2** on the right and left of the deflector **B**.

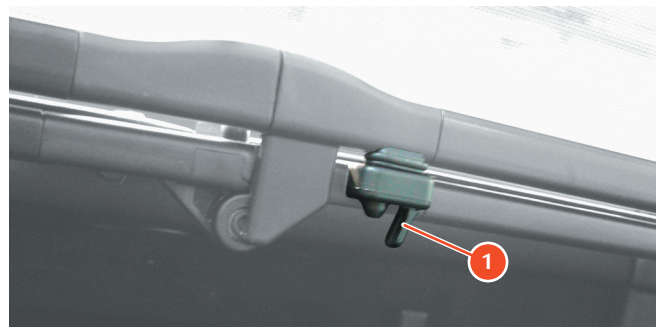

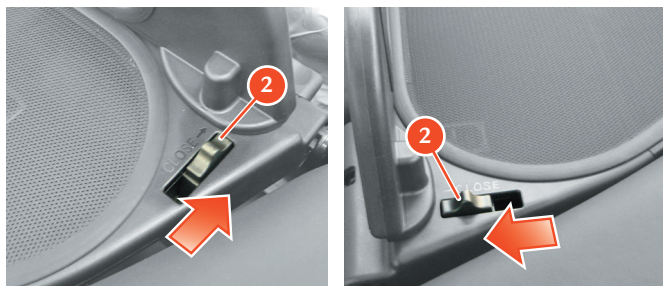

- Push the pin 3 until it snaps into place.



- Place the deflector with supports 4 in the special slots on the left and right of the vehicle and pin 3 in the special hole on the right of the vehicle.

Important note



Pay attention to the vehicle trim.

- Push the other snap-in-place pin 3 into the special hole on the left of the vehicle.

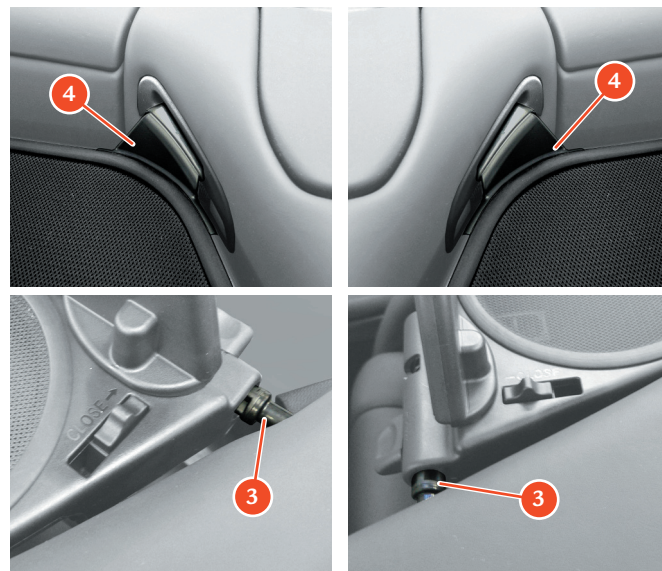

Warning



When the deflector is fitted, do not tilt the front seats too far back if they are moved right back into the end stop position to avoid damaging the deflector.

Warning



Check that the deflector has been secured correctly!

1. General
2. Quick reference guide
3. Safety
4. About your vehicle
- 5. Advice for Emergency Situations**
6. Care of the vehicle
7. Glossary
8. Table of Contents



Warning



Repair work using the toolkit requires:

- suitable protective equipment (e.g. gloves);
- adequate precautions to be taken (e.g. during tyre replacement never lie under a vehicle raised by a jack);
- minimum specific expertise when working in contact with electrical parts/components (e.g. battery).

Toolkit

Tool bag

Housed in the luggage compartment, it contains the necessary tools to make a first repair in the event of a failure:

- set of flat wrenches;
- insulated cutting pliers;
- screwdriver for slotted screws;
- screwdriver for crosshead screws;
- tow hook;
- set of light bulbs;
- set of fuses;
- parking brake manual emergency unlocking key;
- “Park Lock” emergency unlocking key;
- tyre inflation kit.



Emergency tyre repair and inflation kit

In the event of a puncture or low pressure of a tyre, the kit can be used to repair and/or inflate the tyre sufficiently to continue the journey safely.

Important note



To use the tyre repair and inflation kit correctly, refer to the instruction booklet supplied with the kit.

Warning



Give the instruction booklet supplied with the kit to the personnel that will have to deal with the tyre treated with the repair kit.

Warning



In the event of a puncture caused by foreign objects, tyres can be repaired with cuts of up to **4 mm** in diameter on the tyre tread and shoulder.

Warning



Punctures cannot be repaired on the sides of the tyre. Do not use the tyre repair kit if the tyre has been damaged after driving with a flat tyre.

Warning



Damage to the wheel rim that causes air leaks cannot be repaired. Do not remove foreign objects (screws or nails) that have penetrated the tyre.

Warning



After using the repair kit, the vehicle must however be considered to be in an emergency situation: drive with the greatest care (maximum permissible speed 80 km/h - 50 mph).

Warning



Apply the sticker where it can easily be seen by the driver to indicate that the tyre has been treated with the tyre repair kit.
Drive carefully especially on bends.
Avoid sudden accelerating or braking.

Warning



The kit is to be used to temporarily repair only one tyre punctured by small objects: the kit may not be useful in the case of large punctures or tearing.

Important note



After driving for approximately 10 minutes, stop and recheck the tyre pressure.
Remember to use the handbrake.

Warning



If the pressure has dropped below **1.8 bar**, do not continue driving: the kit cannot guarantee the correct hold because the tyre is too damaged. Contact the Ferrari Service Network.

If the tyre pressure is at least **1.8 bar**, restore the correct pressure and continue driving.

Drive very carefully to the nearest FERRARI SERVICE NETWORK.

Warning



The repaired tyre must be replaced as soon as possible and the workshop personnel must be informed that the tyre was treated with tyre repair fluid.

Warning



Keep the kit in its box and out of children's reach.
Do not inhale or swallow the fluid contained in the cartridge and avoid contact with the skin and eyes.

Warning



The spray contains ethylene glycol.

It contains latex: it may cause an allergic reaction. Harmful if swallowed. Irritating to eyes. May cause sensitisation by inhalation and skin contact. Avoid contact with eyes, skin and clothing. In case of contact, rinse immediately with plenty of water. If swallowed, do not induce vomiting, rinse mouth, drink plenty of water and seek immediate medical advice. Keep out of reach of children. The product should not be used by asthma sufferers. Do not inhale vapours when using. In the event of an allergic reaction, seek immediate medical advice. Store the spray can in its special case away from sources of heat.

The liquid sealant has an expiry date.

Environment



Replace the spray can containing the expired liquid sealant. Do not dispose of the spray can in normal domestic waste. Dispose of in accordance with national and local regulations.

Warning



The sealant in the kit cartridge can damage the sensor inside the wheel rim on vehicles fitted with a tyre pressure monitoring system.

If this occurs, the sensor must be replaced. Contact the FERRARI SERVICE NETWORK.

Warning



Wear the protective gloves supplied with the tyre repair kit.

Useful accessories

In addition to the tools supplied with the vehicle, the hazard warning triangle and fluorescent safety jacket should always be kept on board in order to signal hazardous situations in compliance with regulations.

Replacing the headlight bulbs

Important note



The low/high beams are equipped with bi-xenon light bulbs.
To replace the headlight bulbs, contact the Ferrari Service Network.

To adjust the headlight beam, please contact the FERRARI SERVICE NETWORK.

Replacing the taillight bulbs

Important note



Before replacing a beam bulb, make sure that the fuse is not blown.

Disconnect the battery using the quick release.

To replace a rear bulb, proceed as follows:

- move the luggage compartment strip slightly;
- remove the bulb holder **N**;
- remove the bulb by pulling it out and replace it;
- put the bulb holder back in place and reposition the luggage compartment perimeter seal strip.

Replacing the supplementary taillight bulbs

Important note



To replace the supplementary taillight bulbs, contact the FERRARI SERVICE NETWORK.

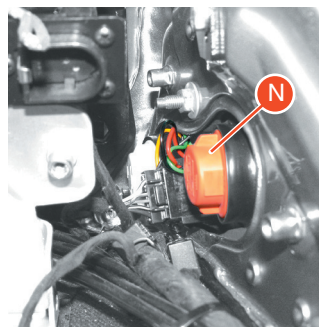

Replacing the number plate light bulb

To replace a number plate light bulb, proceed as follows:

- unscrew the two lid fastener screws;
- remove the transparent cover **A** from its housing and replace the bulb **B** snapped in place between the two clips;
- refit the transparent cover and screw up the two fastener screws.

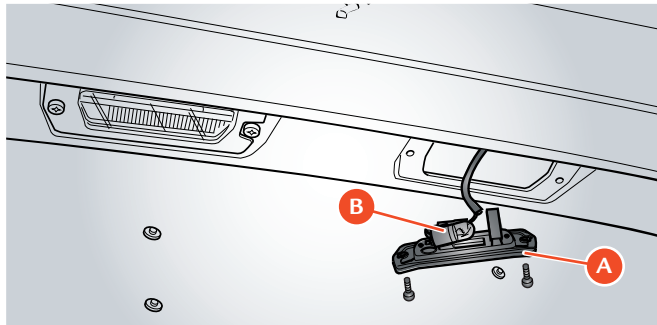

Replacing other light bulbs

Roof panel dome light

- Use a screwdriver to gently prise off the edge of the transparent cover **C** of the dome light and remove it from the roof panel.
- Replace the bulb **D** or **E** or **F**
- Refit the dome light and make sure that the wires are not pinched by inserting it first from the connector side and then pressing on the opposite side.

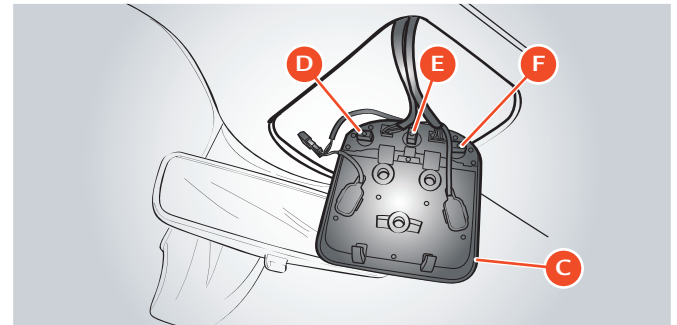

Glove compartment and luggage compartment light

- Use a screwdriver to gently prise under the edge of the transparent cover **G** and lift it.
- Completely remove the transparent cover from its housing.
- Take the bulb out of its clips.
- Replace the bulb.
- Refit the transparent cover and make sure that the wires are not pinched by inserting it first from the connector side and then pressing on the opposite side.

Replace the luggage compartment light bulb in the same way

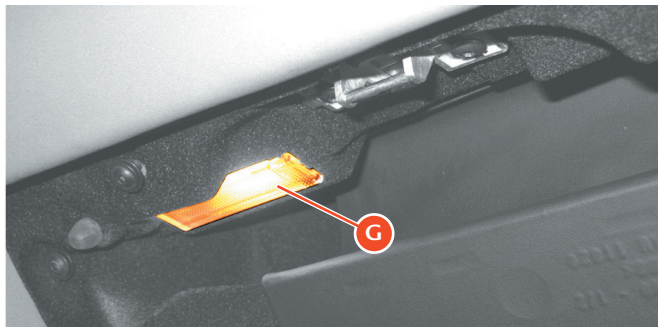

Underdoor light

- Use a screwdriver to gently prise under the edge of the transparent cover and lift it.
- Completely remove the transparent cover from its housing.
- Take the bulb **G** out of its clips.
- Replace the bulb.
- Refit the transparent cover and make sure that the wires are not pinched by inserting it first from the connector side and then pressing on the opposite side.

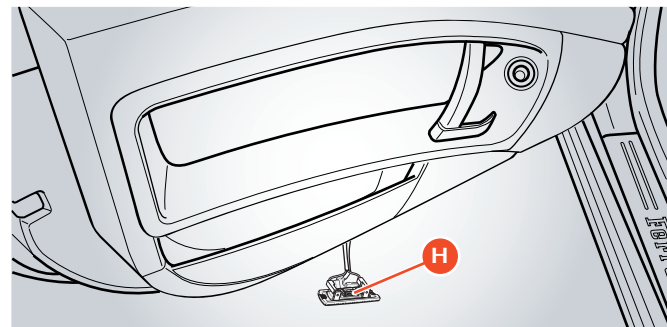

Light bulbs (12 V except for high beam and low beam)

| | Type | Power |
|---|-----------------------|--------|
| Low beams and high beams | gas-discharge (XENON) | Das |
| Front running lights | LED | |
| Front turn indicators | LED | |
| Side turn indicators | incandescent | T4W |
| Upper rear headlight | LED | |
| Number plate lights | incandescent | R5W |
| Supplementary stop lights | LED | |
| Fixed part of reverse lights | incandescent | 16W |
| Running/stop lights on moving part of taillight | incandescent | 21W/5W |
| Fixed part of rear turn indicators | incandescent | 21W |
| Rear fog lights | incandescent | H16W |
| Dome light | incandescent | 8W |
| Spotlight | incandescent | 5W |
| Glove compartment light | incandescent | W5W |
| Underdoor courtesy light | incandescent | W5W |
| Luggage compartment light | incandescent | 10W |

Replacing a fuse

When an electrical device is not working, check that the corresponding fuse is not blown.

A - Unblown fuse.

B - Blown fuse.

Important note



If the problem persists, contact the **FERRARI SERVICE NETWORK**.

Important note



When replacing a fuse, always use fuses of the same amperage (same colour).

The toolkit contains spare fuses.

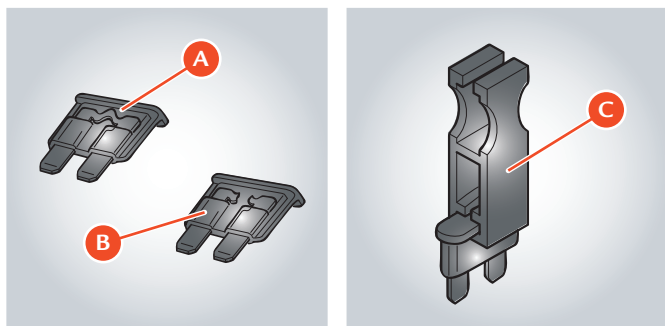

Use the pliers **C** in the fuse box in the passenger compartment behind the dashboard to the left of the steering wheel to remove the fuses.

Fuse colour

| | Ampere |
|--------------|--------|
| yellow ochre | 5 |
| brown | 7.5 |
| red | 10 |
| light blue | 15 |
| yellow | 20 |
| white | 25 |
| green | 30 |

Maxi fuse colour

| | Ampere |
|--------|--------|
| yellow | 20 |
| green | 30 |
| orange | 46 |
| red | 50 |
| blue | 60 |

Location of the fuse and relay boxes

- A - Fuses and relays in engine compartment
- B - Body Computer fuses and relays
- C - Fuses and relays in passenger compartment on passenger side
- D - Fuses and relays in passenger compartment on centre console

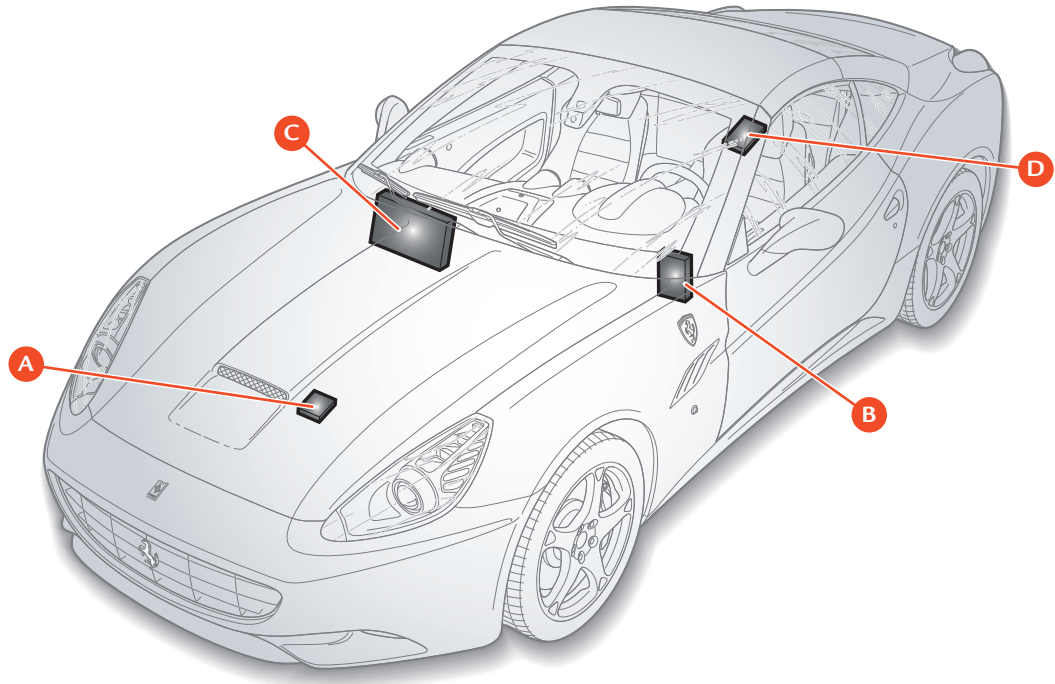

Fuses and relays in the engine compartment

To access these fuses:

- open the engine compartment lid
- remove the box cover **A**.

Important note



Only open the boxes containing the fuses that need to be checked to avoid damaging other components.

Box **A** contains these fuses:

| Ref. | Amp. | Use |
|------|------|--|
| CAL2 | CAL2 | Power supply (starter motor and alternator). |
| F-70 | 150 | Power supply and engine relay |
| F-71 | 40 | Hard top pump |

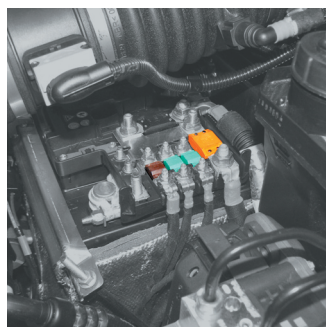
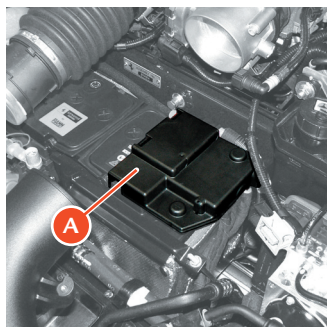

| | | |
|------|----|---------------------|
| F-72 | 40 | Parking brake power |
| F-73 | 70 | Dashboard ECU power |

Body Computer fuses and relays

To access these fuses, remove the flap **1** by unscrewing the two fastener screws.

Box **B** contains the following relays (**R**) and maxi fuses (**MF**):

Important note



Only open the boxes containing the fuses that need to be checked to avoid damaging other components.

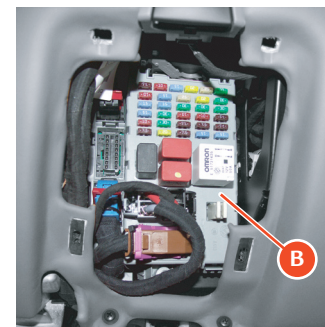
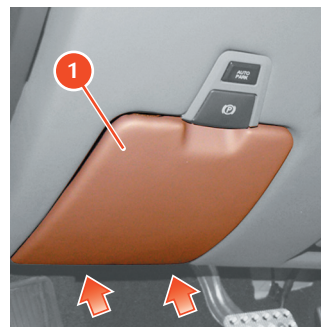

The box **A** contains the following relays (**R**) and maxi-fuses (**MF**):

| Ref. | Amp. | Use |
|------|------|---|
| F-12 | 15 | Right high beam |
| F-13 | 15 | Left high beam |
| F-31 | 7.5 | AC unit, body computer connector |
| F-32 | 10 | Dome lights, foot well and puddle lights, side markers, supplementary taillights. |
| F-35 | 7.5 | Clutch pedal control, Cruise control, Power steering, Beams. |
| F-36 | 10 | Satellite alarm system, parking sensors, fuel filler flap. |
| F-37 | 10 | Stop light control. |
| F-38 | 15 | Luggage compartment lock |
| F-39 | 15 | Radio, diagnosis socket, CAN box interface. |
| F-40 | 30 | Heated rear screen |
| F-42 | 7.5 | Alternator |
| F-43 | 30 | Windscreen wipers |
| F-44 | 20 | Passenger seat heating, cigarette lighter |
| F-46 | 20 | Hard top |
| F-47 | 30 | Driver-side door |
| F-48 | 30 | Passenger-side door |
| F-49 | 7.5 | Passenger compartment lighting switches and controls |
| F-50 | 7.5 | Air bags |
| F-51 | 7.5 | Semi-automatic gearbox, engine start button |

| | | |
|------|-------|-----------------------------------|
| F-52 | 15 | Power socket, driver seat heating |
| F-53 | 10 | Instrument panel |
| T01 | 20 | Low beam relay |
| T11 | 30 | Heated rear screen relay |
| T12 | 30 | Relay services 1 |
| T13 | joint | Supply jumper services 2 |

Passenger side fuses and relays

To access these fuses, remove the passenger footrest **2** by unscrewing the four fastener screws.

Box **C** contains the following relays (**R**) and fuses (**F**):

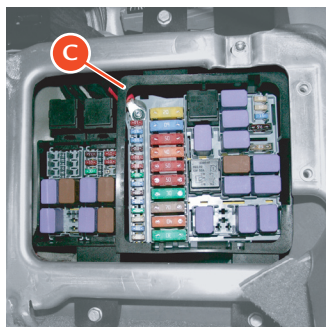
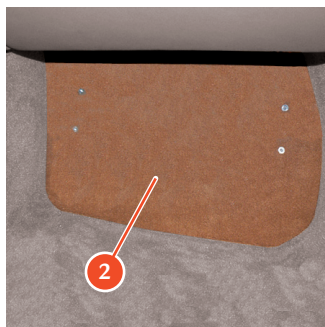

| Ref. | Amp. | Use |
|------|------|---|
| F-01 | 60 | +30 Radiator fans (first speed) |
| F-02 | 30 | +30 ABS (valves) |
| F-03 | 30 | +30 Ignition switch |
| F-04 | 50 | +30 ABS (pump) |
| F-05 | 40 | +30 Air conditioning and heating system |
| F-06 | 50 | +30 Radiator fans (second speed) |
| F-07 | 20 | +30 Horns |
| F-08 | 7.5 | Air conditioning and heating system compressor |
| F-09 | 7.5 | +30 Supplementary stop lights |
| F-10 | 15 | +30 luggage compartment lock relay |
| F-11 | 25 | Left bank oxygen sensors |
| F-14 | 15 | +30 high beams |
| F-15 | 7.5 | +30 alternator sensing |
| F-16 | 25 | +30 Right bank engine control power supply |
| F-17 | 25 | +30 Left bank engine control power supply |
| F-18 | 10 | +30 Left cylinder bank injection system power supply, LH cylinder bank injection main relay coil |
| F-19 | 10 | +30 Right cylinder bank injection system power supply, RH cylinder bank injection main relay coil |
| F-20 | 30 | +30 right injection system main relay |
| F-21 | 15 | +30 Fuel pump 2 |

| | | |
|------|----|--|
| F-22 | 15 | Left bank (ignition coil) |
| F-23 | 10 | +30 ABS (electronic) |
| F-24 | 15 | Right bank (ignition coil) |
| F-30 | 30 | +30 Starting relay |
| F-81 | 40 | +30 Supplementary ECU power supply |
| F-82 | 70 | +30 Dashboard ECU and luggage compartment ECU power supply |
| F-83 | 50 | +30 Air pump relay |
| F-84 | 15 | +30 Fuel pump relay 1 |
| F-85 | 25 | Headlight washer |
| F-87 | 25 | Right bank oxygen sensors |
| F-88 | 10 | +15 left cylinder bank injection system |
| F-93 | 30 | +30 suspension control node fuse |
| T02 | 30 | High beam relay |
| T05 | 30 | Fuel pump relay 2 |
| T06 | 30 | Luggage compartment lock actuator relay |
| T07 | 50 | Horn relay |
| T08 | 30 | Air conditioning and heating system compressor relay |
| T09 | 30 | Left cylinder bank injection system main relay |
| T10 | 30 | Right cylinder bank injection system main relay |
| T14 | 30 | Fuel pump relay 1 |
| T15 | 50 | Radiator fan relay (second speed) |

| | | |
|-----|-------|---|
| T16 | 50 | Radiator fan relay (first speed) |
| T17 | 10/20 | INT/A relay (devices excluded at ignition) |
| T19 | 30 | Stop light control relay. |
| T20 | 30 | Starting relay |
| T26 | 30 | Windscreen wiper relay (first speed) |
| T27 | 30 | Windscreen wiper relay (second speed) |
| T28 | 30 | Windscreen washer pump relay |
| T29 | 30 | Supplementary stop light relay (third stop light) |
| T30 | 50 | Air pump relay |
| T37 | 30 | Left supplementary taillight relay |
| T38 | 30 | Left headlight LED module power supply relay |
| T39 | 30 | Right headlight LED module power supply relay |
| T31 | 30 | Headlight washer pump relay |

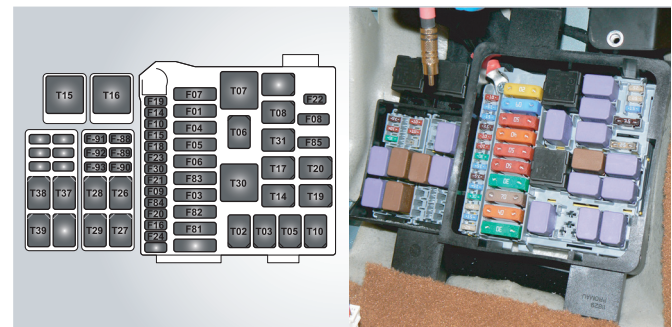

Fuses and relays on centre console

To access these fuses, remove flap **3** from the centre console.

Box **D** contains the following relays (**R**) and fuses (**F**):

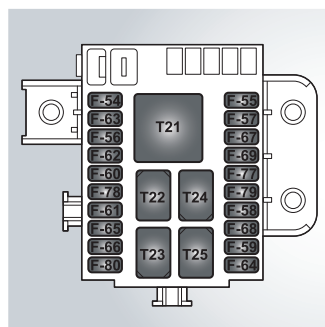

| Ref. | Amp. | Use |
|------|------|---------------------------------------|
| F-54 | 2.0 | +30 HI-FI amplifier |
| F-56 | 30 | +30 Driving position |
| F-57 | 7.5 | Side Markers 1 (LH front and RH rear) |
| F-59 | 7.5 | Reverse lights |
| F-60 | 30 | +30 Passenger position |
| F-61 | 7.5 | +30 Driving position (electronic) |
| F-62 | 7.5 | +30 Passenger position (electronic) |
| F-63 | 15 | +30 Semi-automatic gearbox main relay |
| F-64 | 7.5 | Fuel filler flap actuator |
| F-65 | 20 | Door lock actuator |
| F-66 | 7.5 | +30 Semi-automatic gearbox |
| F-67 | 7.5 | Side Markers 2 (RH front and LH rear) |
| F-78 | 15 | +30 Battery charger |
| F-80 | 30 | +30 BassBox amplifier |
| T21 | 50 | Side Marker relay |
| T22 | 30 | Reverse light relay |
| T23 | 30 | Fuel filler flap relay |
| T24 | 30 | Supplementary taillight relay |
| T25 | 30 | Semi-automatic gearbox main relay |

Replacing a wheel

Important note



If one or more wheels need to be replaced, proceed as follows:

- replace the wheel stud bolts with damaged threads or tapers
- carefully clean the wheel stud bolts before fitting
- do not lubricate the contact surfaces between the stud bolt and the wheel rim and between the wheel rim and the brake disk.

In order not to remove the antilock coating, do not clean the wheel rim cones with solvents or aggressive products.

Collapsible spare wheel

On request, the vehicle comes with a kit containing:

- collapsible spare wheel **A** with space-saving tyre; the label **B** indicates the maximum speed allowed of 80 km/h

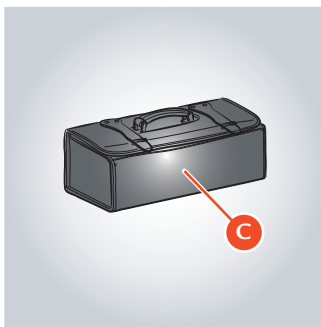
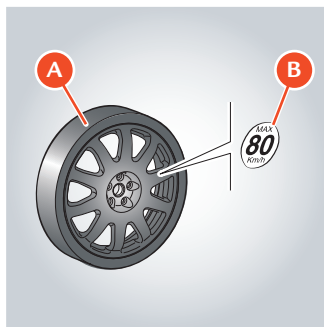

- additional tool bag **C** containing: jack and wrench to fasten the wheel stud bolts.

Warning



The spare wheel must only be used for short trips in the event of an emergency.

When the spare wheel is fitted, never exceed the maximum speed of 80 Km/h (50 mph) and drive carefully, especially around bends and when overtaking, avoiding sudden accelerating or braking.

Do not exceed the approved weight limits.

Do not fit snow chains on the spare wheel.

Never fit more than one spare wheel at a time.

Important note



Failure to comply with these instructions could lead to loss of control of the vehicle and consequently damage to the vehicle and injuries to its occupants.

Replacing a wheel

- Position the vehicle on an even surface, then block the rear wheels by applying the parking brake.

Warning



Make sure that the vehicle is in a safe position.

- If necessary, switch on the hazard warning lights and place the hazard triangle at the required distance from the vehicle.
- Take the spare wheel and tools out of the luggage compartment.
- Loosen the five wheel stud bolts approximately one turn each using the wrench **D** provided.
- Place the base of the jack **E** on flat firm ground under one of the jacking points **F** on the underfloor as shown in the figure.

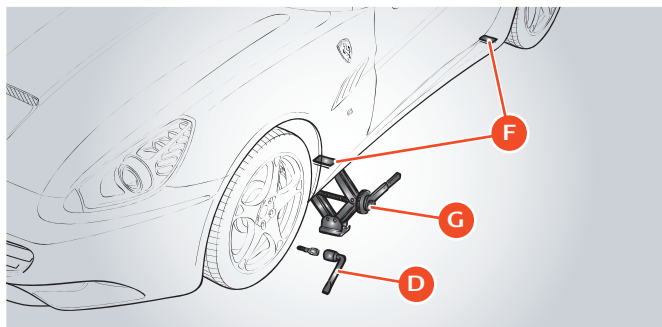

- Lift the vehicle carefully using the jack **G** until the wheel is raised off the ground.

Warning



If the jack is not positioned correctly, the vehicle could slip off. No part of the body must ever be under the vehicle. The supplied jack must only be used for replacing wheels.

- Unscrew the five stud bolts and remove the wheel.
- Fit the uninflated collapsible spare wheel.
- Screw the stud bolts into place but do not tighten them.

Warning



Inflate the collapsible spare wheel before lowering the vehicle to avoid damaging the rims.

- Inflate the collapsible spare wheel using the inflation kit.

Warning



The kit must be used in “tyre inflation” mode. Refer to the instruction manual supplied with the kit.

- Inflate to the indicated pressure (see page 28).
- Lower the vehicle and remove the jack.
- Tightly fasten the stud bolts, alternately going from one stud bolt to one that is diametrically opposite.

As soon as possible, secure the stud bolts with the torque wrench and tighten them to a torque of 100 Nm.

Warning



The spare wheel does not have a tyre pressure monitoring sensor (see label on spare wheel tool bag). After fitting, it is not checked by the system but conforms to the international regulations ECE R64/01.

After fitting, we recommend going to the nearest FERRARI SERVICE NETWORK.

Towing

When towing the vehicle, avoid using anchor points that are not those for the tow hook **A** inserted in housing **B**.

- Take the tow hook **A** out of the tool bag.
- Tightly screw the tow hook into housing **B**.
- Release the EPB.
- Release the Park Lock.

Warning



If there is an electrical system failure, release the EPB and Park Lock manually.

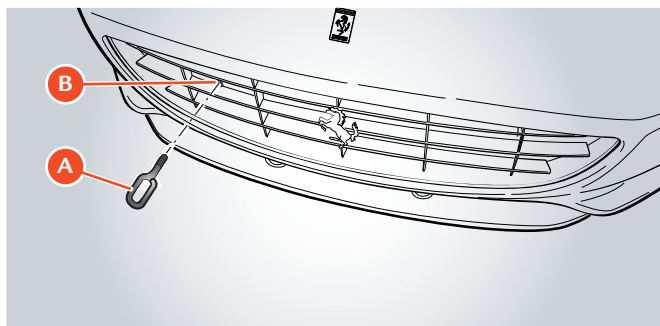

Warning



While towing the vehicle, you must comply with Road Regulations.

Warning



Do not tow the vehicle by attaching it to levers, suspension and wheel rims but only to the tow hook properly fitted in its housing.

Keep the key into position **II** to enable the lights to work and prevent the steering wheel locking in the event of steering; when towing the vehicle, do not start the engine.

Important note



Remember that when the engine is switched off, the power steering and brake servo functions do not work.

Fuel inertia switch

This is a safety switch **A** in the passenger compartment on the floor in front of the driver seat that deactivates the petrol pump relays if a collision occurs.

A symbol on the TFT display and the hazard warning lights light up to indicate that the switch has been activated.

When activated, the doors are also unlocked (if locked) and the central dome light comes on.

Warning



The system can be reactivated by pressing the button on the top of the switch.

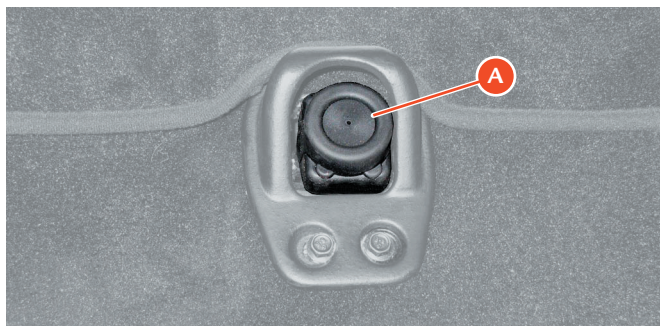

Battery quick release

It is on the left side of the battery and can be accessed by opening the engine compartment lid.

Use locking lever **B** to loosen the clamp.

Separate the clamp from the battery to disconnect the battery and the electrical system.

Warning



The battery master switch must only be used if the battery conditioner cannot be connected.

Warning



Place the clamp so that it does not come into contact with the battery pole or other metal parts of the vehicle.

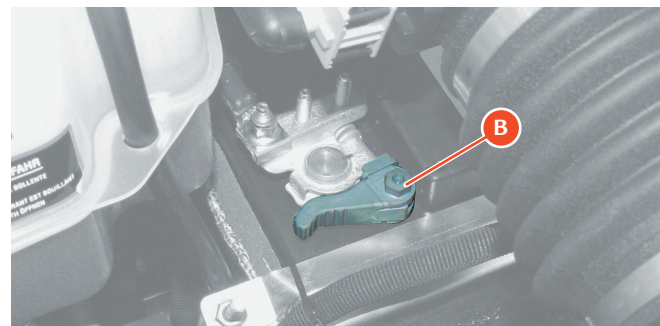

Disconnecting the battery

Before disconnecting the battery, deactivate the electronic alarm using the remote control.

Warning



Never disconnect the battery from the electrical system when the engine is running.

Before disconnecting the battery, lower the side windows by at least 2-3 centimetres to avoid damaging the strips when opening and closing the doors.

Warning



When the battery is connected and charged, this operation is automatically performed when the doors are opened and closed. The windows must remain lowered until the charged battery is reconnected. If the battery is discharged with the windows completely raised, only open the door if necessary and use the utmost caution; do not close the door again until the windows can be lowered.

Important note



We recommend using the battery conditioner if the vehicle will not be used for a long period.

Reconnecting the battery

Place the clamp on the battery and fasten it by closing the locking lever.

Each time the battery is reconnected, before starting the engine, do the following:

- close both doors and close the luggage compartment lid; unlock and lock the doors using the remote control; open the luggage compartment lid using the remote control.
- adjust the clock (date and time on instrument panel);
- Close both doors and fully raise the driver side and passenger side windows to their upper limit; check that the windows move down into the “target position” when the doors are opened.

Warning



WAIT at least 1 minute before inserting the key in the ignition switch.

Before starting the engine, wait at least 60 second with the ignition key in position **II** to allow the electronic system that controls the motor-driven valves and the A.C. ECU to run a self-learning process.

During this period, no devices must be activated.

The self-learning process for the Motronic ECUs works properly when the intake air temperature is above 5 °C.

After removing the battery from the vehicle or disconnecting from the electrical system using the battery master switch, it is important to check that the external temperature is within the indicated values when reconnecting before effecting the self-learning process.

Checking the battery

The battery is placed in the centre of the engine compartment.

The vehicle is equipped with a sealed lead acid battery that does not require maintenance.

Warning



The battery does not need topping up with distilled water or sulphuric acid.

- Periodically check that the terminals and pins are clean and firmly secured.
- Visually inspect the outer casing for any cracks.
- If the battery overcharges, it will wear out quickly. Have the vehicle electrical system checked if the battery tends to discharge easily.

Warning



Do not place the battery near sources of heat, sparks or naked flames.

Battery conditioner

The vehicle is equipped with a battery conditioner to maintain and recharge the battery.

Important note



Using the battery conditioner will extend the life of the battery.

The device is kept in a pocket inside the car cover bag provided with the vehicle.

The battery conditioner connection socket is located on the right of the luggage compartment behind cover **B**.

To access socket **D** rotate the fastener **C** and open the flap **B**.

Warning



Place the battery conditioner where it can be easily seen away from heat sources and out of children's reach.

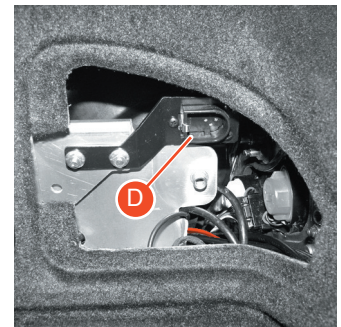
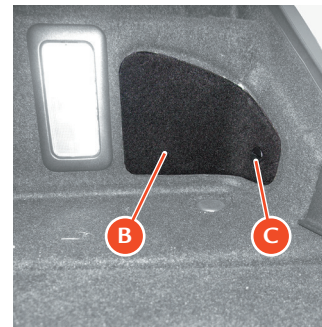

After connecting the battery conditioner to the socket in the vehicle, run the connection cable underneath the luggage compartment lid in the outer/rear corner.

Important note



Do not run the connection cable out of the vehicle in positions other than those indicated to prevent damaging the seals and/or the cable.

If the car is not to be used for periods longer than one week, we recommend that you connect the maintainer in order to keep the battery in good working order.

Warning



The engine cannot be started as long as the battery conditioner is connected to the vehicle socket.

Important note



Additional technical information on the use of the device can be found in the manual provided inside the pocket of the car cover bag.

Exhaust system overheating alarm devices

If the engine malfunctions with consequent high temperature in the exhaust system, a symbol will appear on the TFT display accompanied by a message. The message varies according to the three alarm levels: **high temperature**, **excessive temperature** or **catalytic converter temperature system failure**.

Display of the symbol is controlled by the thermistor via the engine control ECU.

Warning



Incorrect use of the vehicle may cause the SLOW DOWN warning light to come on.

Warning



If the temperature is **high**:
slow down immediately so that the exhaust system temperature drops.

Warning



If the temperature is **excessive**:
the temperature in the catalytic converters has reached a dangerous level and could damage them; if you continue to drive, the engine control ECU intervenes and reduces the torque produced by the engine.
The torque limit remains until the catalytic converter temperature drops to normal operating values.

Warning



If catalytic converter temperature system failure information is displayed:

- the engine control ECU intervenes and reduces the torque produced by the engine
- the driver must slow down and slowly drive to the nearest FERRARI SERVICE NETWORK to have the engine parameters checked.

Warning



If the EOBD warning light comes on at the same time as the SLOW DOWN warning light, go the nearest FERRARI SERVICE NETWORK to have the ECU error memory checked.

Warning



FERRARI is not liable for any damage to property or personal injury arising from failure to comply with the warnings stated above.

Engine malfunction alarm devices

If the “Engine diagnostic system failure” (EOBD) warning light flashes or illuminates permanently while the engine is running, it indicates that the engine or the emission control system may be malfunctioning.

The electronic system detects and isolates the error preventing damage to the engine or the production of harmful emissions.

Warning



When the “engine diagnostic system failure” warning light comes on, engine performance may be considerably reduced.
Drive carefully, avoiding sudden acceleration and high speeds.
Contact the FERRARI SERVICE NETWORK immediately.

Replacing brake pads and discs

Brake pads

The front brake pads have a wear detector connected to the brake warning light; if this warning light comes on or braking is not even, have the pad thickness and the state of the braking surfaces checked.

The minimum brake pad thickness is 3 mm (thickness of the friction material only).

Replacing brake pads

When the brake failure warning light comes on, it means that the front brake pads are excessively worn and must be replaced immediately.

Warning



To guarantee the quality of the components and perfect installation, we recommend having brake pads replaced at a **FERRARI SERVICE CENTRE**.

After replacement, avoid sudden braking until the new pads are seated properly (approximately 300 km).

Manual closing of retractable hard top

Warning



For manual closing of the retractable hard top, two people are required.

The movements must be slow and synchronised.

If the retractable hard top cannot be moved electronically, it can be closed and moved manually. To perform the operations described below, two people are required.

- Completely lower the side windows.
- Open the luggage compartment lid.
- Disconnect the battery by detaching the quick release.
- Lift up the luggage compartment lid.
- Open the left **A** and right **B** sections of the luggage compartment by turning the relative fasteners **C**.

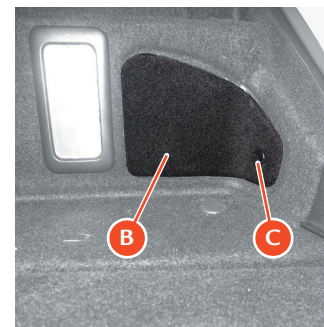
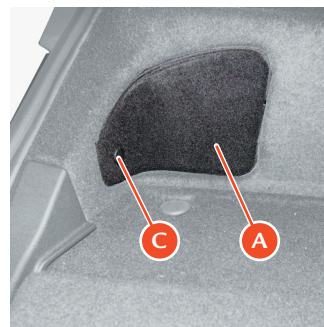

- Locate the Tonneau Cover latch **D** in the left section.
- Locate the Tonneau Cover latch **E** in the right section.
- Insert the special key in the tool kit supplied with the vehicle in the Tonneau Cover housing.
- Turn the key clockwise to release the left Tonneau Cover latch and turn the key counterclockwise to release the right Tonneau Cover latch.

Warning



Make sure that flaps **F** and **G** shown in the figure have opened correctly. If they are not fully open, **DO NOT** effect the emergency manoeuvre to avoid causing possible damage.

- Lower the luggage compartment lid.

Warning



DO NOT close the luggage compartment completely.

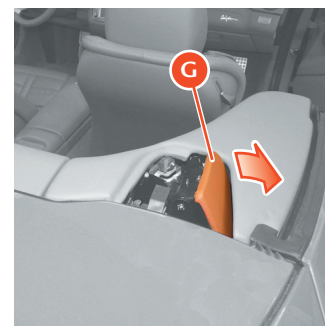
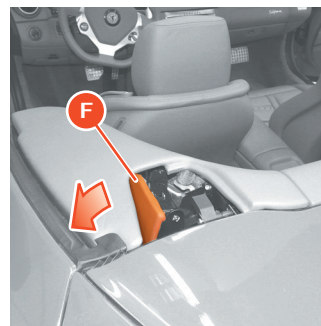
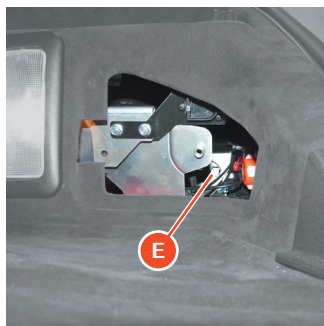
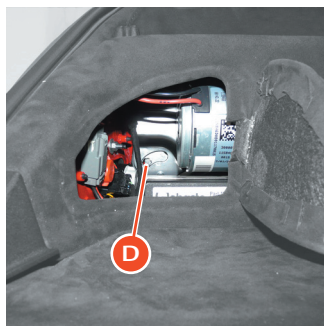

- Lift up the Tonneau Cover until it is completely open.

Important note



Two people are required to open and close the retractable hard top using slow, synchronised movements.
Use the holds as shown in the figure by the arrows.

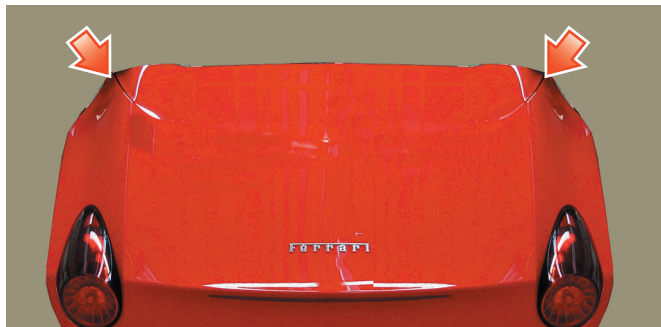

- Hold the front - rear roof package stored in the luggage compartment and get ready to lift it.

Important note



To do this, hold the package with both hands working on both sides of the vehicle.

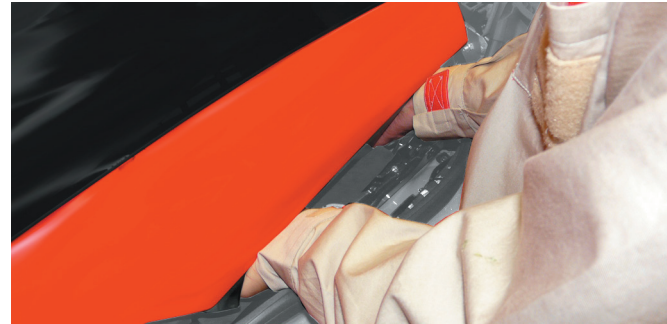

- Lift the front-rear roof package right up and let it drop down until it touches the windscreen pillars.
- Lower the Tonneau Cover and let it drop until it has gone into its housing.



- Lift up the luggage compartment.
- Lock the Tonneau Cover latch.
- Insert the key in housing **D** on the left of the luggage compartment and turn counterclockwise.
- Insert the key in housing **E** on the right of the luggage compartment and turn clockwise.

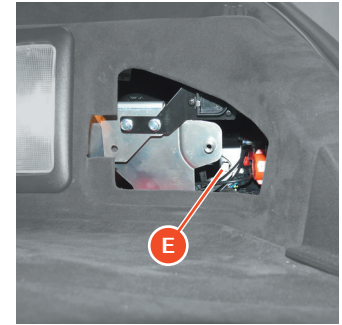
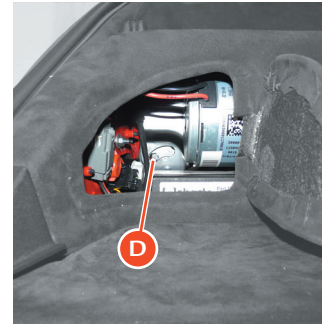

- Close the rear roof by holding it with both hands and working on both sides of the vehicle and let it drop down until it goes into its housing.

Warning



To do this, hold the rear roof with both hands and work on both sides of the vehicle.

- Move the roof internal covering fabric **H** until you find the rear roof latch **I**.
- Release the rear roof latch by turning the special key clockwise; do this in the left lock and then the right one by turning the key very carefully to avoid damaging the cover.

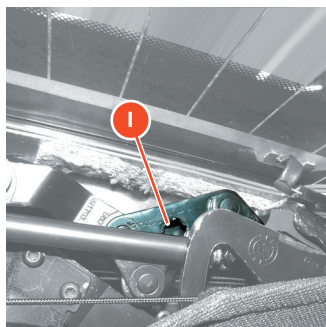

Warning



Make sure that has locked and if not, repeat the procedure.

- Reposition the fabric on both sides.
- Close the left section with fabric **A**.
- Close the right section with fabric **B**.
- Fasten both covers by turning the fasteners **C**.
- Close the luggage compartment lid.

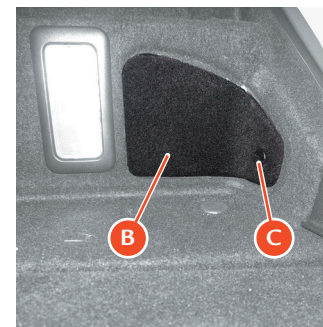
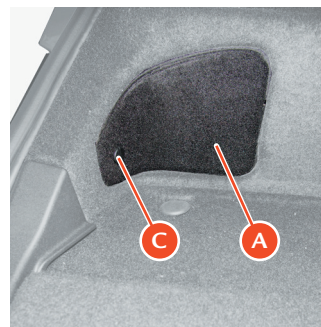

Emergency unlocking of electric parking brake

Warning



When the electric parking brake is deactivated manually, the vehicle may move unexpectedly!

To keep the vehicle stationary, the Park Lock safety device must be applied: make sure that the letter “P” appears on the DOT MATRIX display.

If the electric parking brake cannot be deactivated because the battery is flat or there is a failure in the electrical system that controls it and the vehicle needs to be moved, the emergency procedure described below must be performed.

- Open the luggage compartment lid.
- Remove the tool kit cover.
- Take key **A** out of the tool kit to release the electric parking brake.
- Using the special rectangular groove **B** in the right of the tool kit (marked by a plate), place the release key in the hole (in the left part of the groove) and turn it clockwise.

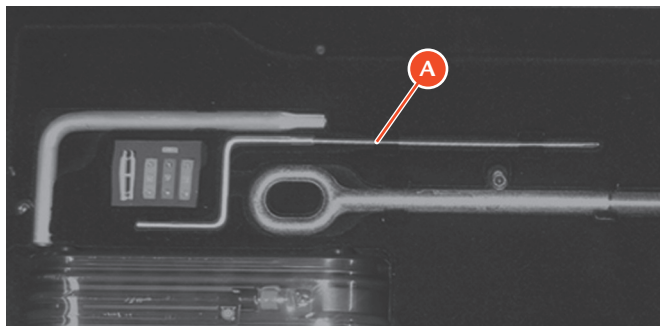

This movement loosens the parking brake cables.

Important note



To release the brake completely, the key needs to be turned 50 times whereas it starts to be released after approximately 20 turns.

Once the electric parking brake has been manually released, the EPB node records a failure at the next key-on and a warning light and the following message “Parking Brake system revision. Go to dealer” is displayed on the TFT display.

Warning



The parking brake resumes normal operating but it is important to go to the nearest workshop to have it calibrated and delete any errors in the error memory.

Go to a FERRARI SERVICE CENTRE.

Calibration is necessary for safety reasons.

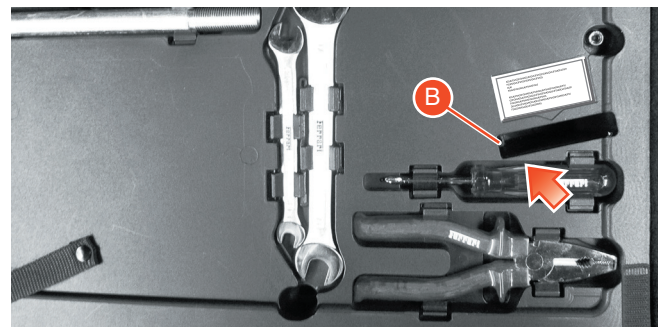

Park lock emergency release.

Warning



However, this should be avoided unless absolutely necessary:

- to tow the vehicle
- if there is a Park Lock failure (the following message is displayed on the TFT display: “Only manual unlock gearbox allowed: See handbook”).

Warning



When the Park Lock safety device is deactivated manually, the vehicle may move unexpectedly.

The vehicle is only kept stationary by the parking brake, if applied.

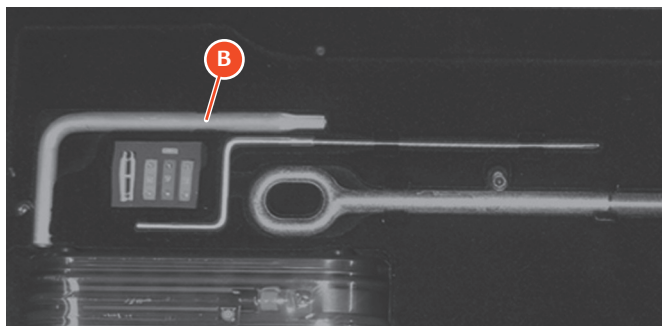

Warning



If the vehicle is not on a level surface, the Park Lock must be released by the device in the passenger compartment.

After releasing the Park lock, the following message may appear on the TFT display “Only manual unlock gearbox allowed: See handbook”

Procedure for releasing the Park Lock from the passenger compartment

Warning



This procedure must only be performed when the vehicle is on a level surface.

The Park Lock manual release device is in the pocket-change compartment on the centre console.

- Take key **B** out of the tool kit.
- Open the pocket-change compartment on the centre console.
- Remove the rubber cap **A**.

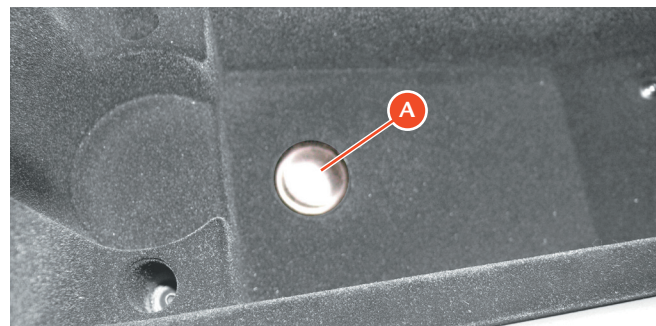

- Place key **B** in the device housing in the pocket-change compartment.
- Turn the key clockwise.

if the electrical system allows it, check that the letter “N” appears on the Dot Matrix display by turning the ignition key to position “II”. The following message “Gearbox not in Parking position” appears on the TFT display.

Important note



Once the vehicle has been moved to a safe place, the Park Lock must be reset.

- Place key **B** in the device housing in the pocket-change compartment.
- Turn the key counterclockwise.

If the electrical system allows it, check that the letter “P” appears on the Dot Matrix display by turning the ignition key to position “II”.

- Close the device hole with the rubber cap **A**.

Warning



In the event of emergency unlocking due to a Park Lock failure, go to the nearest FERRARI SERVICE CENTRE to resolve the problem.

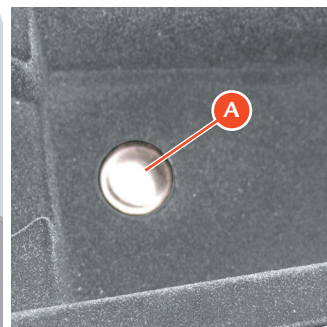
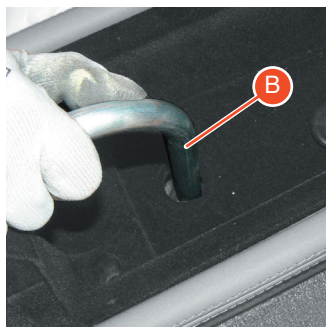

Procedure for releasing the Park Lock from the luggage compartment

Warning



Only release the Park Lock in this way if the vehicle is on a level surface.

Warning



When the Park Lock device is deactivated manually, the vehicle may move.

The vehicle is only kept stationary by the electric parking brake, if applied.

The Park Lock manual release device is in the luggage compartment.

- Take key **B** out of the tool kit.
- Open the luggage compartment.
- Remove the felt cover **E**.

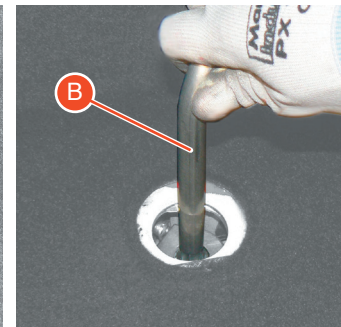
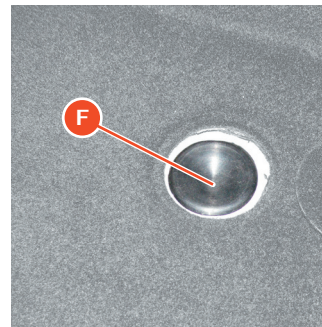
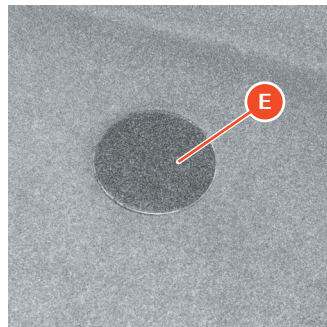
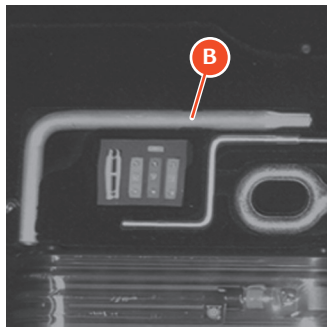

- Remove the rubber cap **F** that protects the device.
 - Place key **B** in the device and turn it clockwise.
- if the electrical system allows it, check that the letter “N” appears on the Dot Matrix display by turning the ignition key to position “II”. The following message “Gearbox not in Parking position” appears on the TFT display.

Important note



Once the vehicle has been moved to a safe place, the Park Lock must be reset.

- Place key **B** in the device housing in the luggage compartment.
- Turn the key clockwise.

If the electrical system allows it, check that the letter “P” appears on the Dot Matrix display by turning the ignition key to position “II”.

- Close the device with the rubber cap.
- Close the device hole with the felt.
- Close the luggage compartment lid.

Warning



In the event of emergency unlocking due to a Park Lock failure, go to the nearest FERRARI SERVICE CENTRE to resolve the problem.

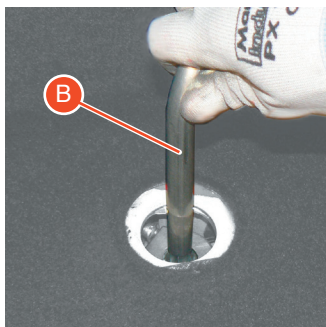

1. General
2. Quick reference guide
3. Safety
4. About your vehicle
5. Advice for Emergency Situations
- 6. Care of the vehicle**
7. Glossary
8. Table of Contents



Warranty Booklet

The vehicle comes equipped with a “Warranty Booklet”. This contains the vehicle’s warranty validity conditions.

Warning



The warranty booklet also contains special blank spaces where the **AUTHORISED SERVICE CENTRES** can register the regular maintenance services performed, as indicated in the maintenance schedule.

Maintenance

It is essential to always keep the vehicle in proper working order to ensure a long working life and to prevent any running defects, caused by negligence or lack of maintenance, and consequently to avoid hazardous situations.

Important note



All repair work on any component of the safety system must be performed by the **FERRARI SERVICE NETWORK**.

Maintenance schedule

At the intervals prescribed, the **FERRARI SERVICE CENTRES** must perform all the tuning and checking operations indicated in the “Warranty Booklet”.

It is however advisable to immediately report any small fault which may occur during use of the vehicle (e.g. small leaks of essential fluids) to **FERRARI SERVICE CENTRES** and not wait until the next service is due to correct the problem.

It is required to have the periodic maintenance services performed at least once a year, even if the specified mileage limit has not been reached (see “Yearly Maintenance” in the “Warranty Booklet”).

Chassis and bodywork maintenance

The chassis has technological and manufacturing specifications that require that any operation be performed by staff specially trained to work with this innovative technology.

It is of crucial importance to use equipment tested by **FERRARI** if the repair work is to be performed in accordance with rules of good workmanship. Proper execution of repair work ensures that the commercial value of the vehicle is preserved and the safety standards are complied with.

Important note



If the chassis is damaged as a result of an accident, **FERRARI** recommends that you contact the **FERRARI SERVICE NETWORK**.

The chassis, under standard conditions of use, requires no maintenance; it is however advisable to contact the Ferrari Service Network at the intervals indicated in the “Warranty Booklet” in order to have it checked.

Level checks

Important note



The level checks must be performed at the intervals indicated in the “Warranty Booklet” or, in any case, before starting a long journey.

Environment



All the materials used for the following operations (e.g. cloths soaked with oil or grease, pans, etc.) must be disposed of in compliance with the environmental protection regulations.

Important note



Only use lubricants and/or fluids recommended by FERRARI (see the “Refilling” table on page 31).

Engine oil

Warning



The engine oil level must be checked when the engine is warm.

Warning



The engine oil level must be checked when the vehicle is on level ground.

The message “checking engine oil level” displayed next to the following symbol on the TFT display indicates to the driver that the engine oil level must be checked.



Proceed as follows:

Run the engine until the engine oil temperature has reached 80 + 90 °C.

- A. Open the engine compartment lid.
- B. Switch off the engine.

Warning



The oil must be checked when the ENGINE IS OFF.

- C. Completely remove the dipstick **1** on the left side of the engine.
- D. Remove the oil top-up cap **2** and wait 5 minutes for the oil to drain back into the oil pan.

Warning



If the oil level is below the “MIN” mark, top it up and then have the system checked by the **FERRARI SERVICE NETWORK**.

- E. Clean the dipstick, insert and remove again and check that the oil level shown on the dipstick **1** is between the **MIN** and **MAX** notches.

Important note



The distance between the **MIN** and **MAX** marks corresponds to approx. 1.5 litres of oil.

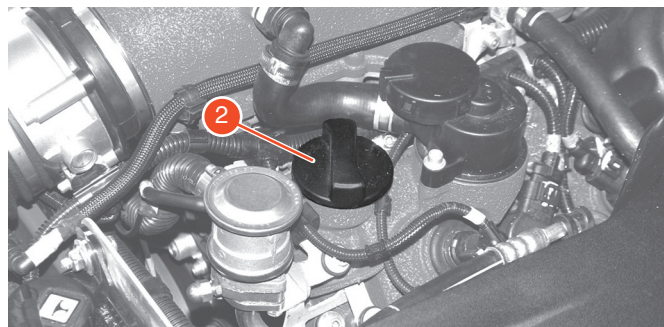

Warning



DO NOT add oil with different characteristics from those of the oil already in the engine.

If the level is close to or under the **MIN** mark, top up with the recommended oil.

Warning



DO NOT fill beyond the **MAX** level.

- F. Top up until the oil reaches the **MAX** level on the dipstick. After the top-up, the “low oil level” warning light on the TFT display may remain on for some time. This is so the system can perform all the necessary checks.

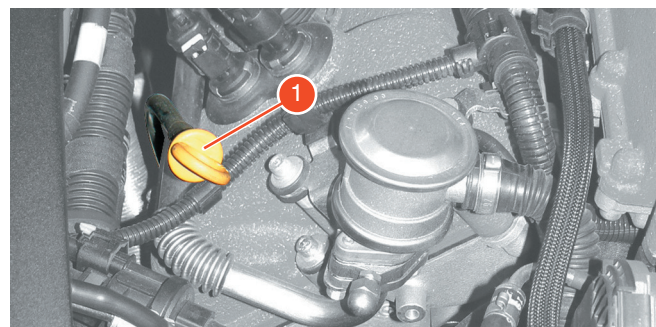

You should therefore consider this behaviour normal.

G. When you have added or changed the oil, recheck the oil level as indicated above.

Environment



Top up with due care to avoid pouring the oil out of the filler neck.

DCT semiautomatic gearbox oil

Important note



We recommend that you have the oil level of the semiautomatic gearbox checked by the **FERRARI SERVICE NETWORK** or by skilled staff.

Coolant

Warning



This procedure must always be performed when the engine is cold. Never remove the cap from the expansion tank when the engine is running or warm.

- Remove the cap **3** from the expansion tank in the engine compartment and check that the level is at approximately 40 mm from the top of the filler neck.
- If the level is low, top it up with the recommended fluid.

Important note



If frequent top-ups are required after short trips, have the system checked by the **FERRARI SERVICE NETWORK**.

- Screw the cap **3** back on tightly.

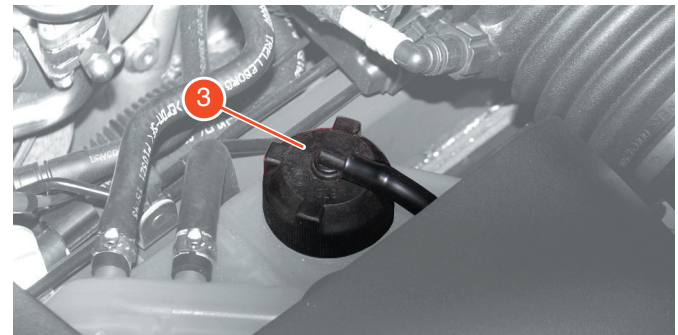

Hydraulic steering system oil

Warning



The power steering oil level must be checked with the engine warm, after having driven at least 15 Km.

Warning



If the oil level is below the “MIN” mark, top it up and then have the system checked by the **FERRARI SERVICE NETWORK**.

The power steering tank is located in the centre of the engine compartment.

Remove the cap **4** from the tank in the engine compartment and check that the level is between the **MIN** and **MAX** marks on the dipstick.

The oil level must be checked with the cap resting on the tank.

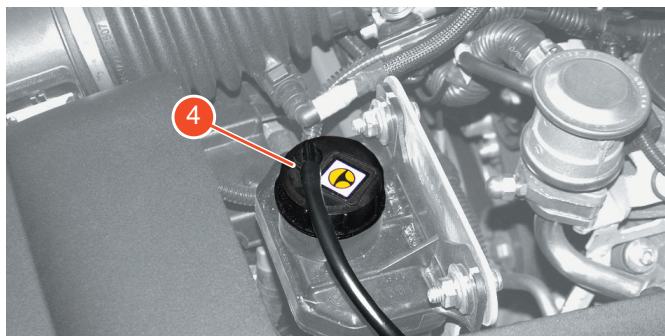

Top up if necessary with the recommended oil up to the **MAX** level. Screw the cap **4** back on tightly.

Environment



Never dispose of used fluid in the environment.

Brake fluid

- Check that the fluid in the tank is near the MAX level.
- If the level is low, unscrew the cap **5** and top up with the recommended oil taken from a sealed container.

Environment



Never dispose of used fluid in the environment.

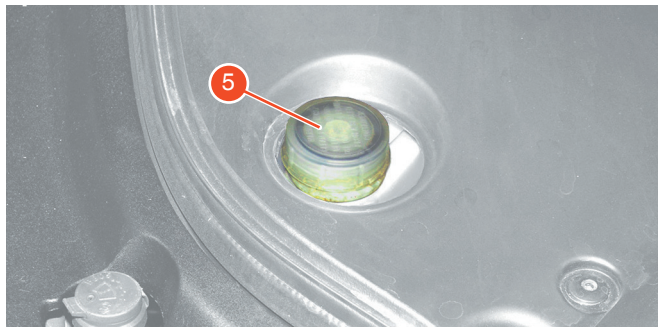

Warning



The oil contained in the brake and clutch systems, in addition to damaging plastic, rubber and painted parts, is highly dangerous if it comes into contact with the eyes or the skin.

In case of contact, wash the affected part thoroughly with running water. To avoid any risk, always use protective goggles and gloves.

Keep out from children's reach!

The symbol on the tank cap **5** indicates that the system contains synthetic fluid.

Warning



The use of mineral-based fluids will irreparably damage the system rubber gaskets.

Do not use fluids other than those already contained in the system for topping up.

- After topping up, screw the filler cap back on.

Windscreen wipers and washer fluid

The tank for the windscreen wipers and washer fluid can be accessed by lifting the engine compartment lid.

- Lift the cap **6** and fill the tank with the recommended fluid (see the “Refilling” table on page 31) until it can be seen in the filling manifold.
- Close the cap **6**.

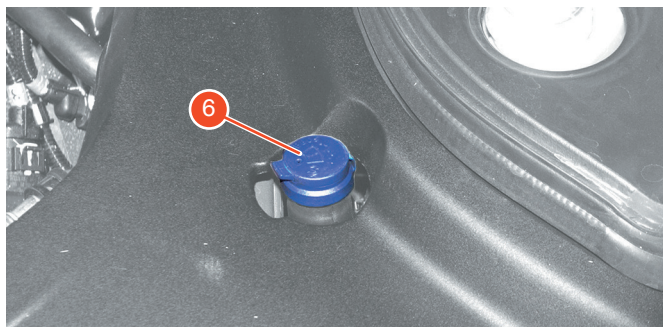

Wheels and tyres

To ensure maximum performance and tyre life and to permit the best tyre adjustment on the wheel rim, it is important to comply with the following instructions for the first 200-300 km (125-185 mi.) with new tyres:

- avoid sudden acceleration
- avoid sharp braking and steering
- drive at moderate speed on straight roads and on curves.

How to use the tyres

Important note



To ensure safe driving, the tyres must be kept in good condition.

The inflation pressure must correspond to the specified values and must be checked only when the tyres are cold: tyre pressure increases as tyre temperature increases.

Never reduce the pressure if the tyres are hot.

Environment



Periodically check the tyres pressure.

Insufficient tyre pressure can lead to overheating, damage and even destruction of the tyres.

Warning



Inflating the tyres to a pressure which is different from that prescribed will render the monitoring system inaccurate.

Sudden impact against sidewalks, holes in the road and other obstacles of various types, as well as long trips on rough roads, can cause damage to the tyres that is not always visible to the naked eye.

Check the tyres regularly for any signs of damage (e.g. scratches, cuts, cracks, bulges, etc.).

If sharp objects penetrate the tyres, they can cause damage which is only visible when the tyre is removed.

Have any damage inspected by an expert as it may considerably reduce tyre life.

Remember that tyres deteriorate over time, even if they are rarely used or not used at all.

Cracks in the tread and side walls, possibly accompanied by bulging, are sure signs of ageing.

Important note



The FERRARI SERVICE NETWORK has the necessary equipment for tyre replacement.

Have the tyres replaced by the FERRARI SERVICE NETWORK who has the equipment needed to avoid damage to the sensor inside the wheel rim which could be caused by carelessly performed procedures.

Ensure that the tyres on stock are not older than 4 years. The maximum life of the tyres kept in stock is of 4 years, provided that they are stored in a place protected from the sun, weather agents and damp, and where there is a low oxygen content.

Important note



The FERRARI SERVICE NETWORK can certify whether aged tyres are suitable for use. In any case, tyres that have remained on a vehicle for more than 3 years must be checked by a FERRARI SERVICE CENTRE.

Warning



We recommend that you replace the tyres every 4 years in case of normal use. Frequent use in maximum load conditions and at high temperatures may accelerate ageing.

Never fit tyres of uncertain origin.

Warning



The tyres are of the “directional” type and there is an arrow marked on their side wall to indicate the direction in which they must rotate or which side is the outer side. In the case of replacement, maximum performance levels can only be ensured if the rotation direction corresponds with the direction indicated by the arrow.

Tyres on the same axle must always be replaced in pairs.

Regularly check the tyre tread (minimum acceptable depth 1.7 mm). As the tread wear increases, there is a greater risk of skidding.

Warning



Drive carefully on wet roads to reduce the risk of “aquaplaning”.

Wheel alignment check and adjustment

When you notice unusual wear of the tyres and in any case, at the intervals prescribed in the “Warranty Booklet”, have the Ferrari Service Network check the wheel toe-in and camber.

Maintenance of the seat belts and pretensioners

- Periodically check that the screws on the anchoring points are tight and that the belt is in perfect condition and slides smoothly.
- The belt must be kept clean; the presence of any dirt could jeopardise the efficiency of the belt winder.
- To clean the seat belt, wash it by hand with mild soap and water, rinse it and let it dry. Do not use strong detergents, bleach or aggressive solvents, as they can weaken the fibres.
- Do not let the belt retractors get wet: proper functioning is ensured only if they are kept dry.
- The pretensioner requires no maintenance or lubrication. If immersed in water or mud, the pretensioner must necessarily be replaced.
- The pretensioner must be replaced at the intervals indicated in the “Warranty Booklet”.

Cleaning the vehicle

Cleaning the exterior

Environment



All the materials used for the following operations (e.g. cloths soaked with oil or grease, pans, etc.) must be disposed of in compliance with the environmental protection regulations.

Proper care of the vehicle on the part of the owner is essential for the vehicle long life.

Below is a list of the main precautions to be taken.

- Certain parts of the vehicle should not be left wet or dirty for long periods of time: in particular, the passenger compartment floor and the luggage compartment must always be kept clean and dry. The draining holes under the doors should be kept unclogged to allow any water to drain.
- The underbody and the lower surfaces of the vehicle should be cleaned regularly, and more frequently (at least once a week) if the vehicle is used on salty or rough roads. The vehicle should be cleaned thoroughly and carefully: cleaning that merely wets encrusted mud without removing it completely can prove damaging.
- The vehicle must be washed regularly with suitable equipment. Do not use very hot water or steam to clean the paintwork and the lower surfaces. It is advisable to soften any dirt first, then remove it with a jet of water at room temperature.

Warning



Do not use aggressive products for cleaning the windows. The use of aggressive products could seriously damage the bodywork.

- Do not wash the vehicle in direct sunlight or when the bodywork is still warm: ensure that the jet of water does not strike against the paintwork too hard. Wash the vehicle with a sponge and a solution of mild soap and water. Rinse the vehicle again with a jet of water and dry it with a piece of chamois leather.

Important note



When the vehicle has been washed, apply slight pressure to the brake pedal at moderate speed before driving at a normal speed, until the brake discs and pads have cleaned off.

In order to maintain the shine of the paintwork, polish it once or twice a year with the products recommended by FERRARI.

- Any areas that are cracked or chipped as a result of stones, scratches or parking manoeuvres, etc., must be immediately repaired by the FERRARI SERVICE NETWORK.
- Do not park the vehicle in damp and/or unventilated areas for long periods of time.

Cleaning of the Antistone Film (optional)

The film has been studied for the protection of the bodywork, all that may damage the paint will also damage the film.

Warning



Do not pour denatured ethyl alcohol, acetone, isopropyl alcohol, heptane or substances that contain these compounds on the film.

- Do not apply adhesive elements on the film.
- When cleaning, do not use metal or abrasive substances in general and acid chemical compounds.

Important note



Avoid contact with the brake fluid as the film will become opaque.

- Do not use solvents along the edges of the film to them from penetrating inside the adhesive layer.

Important note



Avus White, Alloy Grey, Nürburgring Silver vehicles must be washed every month and waxed at least twice a year so that dirt, acid rain, pollutants, etc. do not penetrate the pores of the film causing it to tarnish.

Important note



We recommend that the film be replaced every 24 months for Avus White, Alloy Grey, Nürburgring Silver vehicles, which may show a light visible tarnish due to dirt inside the pores of the film.

It is to be understood that a timely and accurate cleaning (monthly washing and wax twice a year at least) will prevent deterioration.

Cleaning and care of the leather upholstery

As indicated in the “MAINTENANCE SCHEDULE” (see “Warranty Booklet”), proper and regular treatment, at least once a year, will help preserve the quality, natural characteristics and softness of the leather upholstery in your Ferrari.

With this in mind, specific leather care products are also available (“Cleaner” and “Cream”) both tested by FERRARI.

These products can be ordered through the FERRARI SPARE PARTS SERVICE DEPARTMENT, both individually and as part of the “Care Kit” which includes the complete range of products for cleaning the vehicle.

Important note



For use of the “Care Kit” products, contact the FERRARI SERVICE NETWORK.

The following products must be avoided when cleaning the leather: harsh detergents, turpentine, liquid stain removers, petrol, solvents and domestic cleaning products. All of these products damage the

natural material.

Cleaning the interior - Cleaning and care of the Alcantara® upholstery

Warning



Do not use equipment with steam for cleaning!

- Carefully dust the parts to be cleaned
- Use a soft cloth or sponge moistened with clean water
- Squeeze out all the water and treat the entire Alcantara® area being careful not to get it wet in depth.
- Repeat this procedure a second time
- Let it dry completely
- To recondition the material, gently use a brush with soft bristles.

If the vehicle is stored for long periods

If the vehicle is not used for long periods of time, certain precautions should be taken:

- if possible, park the vehicle on a level surface in a covered and well-ventilated area
- prevent the vehicle from moving by putting it into gear
- bring the tyre pressure to 3.0 bar and periodically change the point where the tyres rest on the ground
- connect the battery conditioner

Important note



If you do not wish to connect the battery to the battery conditioner, in order to keep certain devices functioning such as: radio station memory, alarm system, etc., the battery must be recharged at least once a month. If the vehicle is not used for long periods of time without connecting the battery conditioner, the battery must be recharged at least every three months.

- protect the vehicle with a breathable fabric cover, avoiding materials that would prevent any dampness on the bodywork from evaporating.

Before using the vehicle again after long periods of inactivity, adjust the tyre pressure to the indicated pressure and check the fluid levels of all the systems.

1. General
2. Quick reference guide
3. Safety
4. About your vehicle
5. Advice for Emergency Situations
6. Care of the vehicle
- 7. Glossary**
8. Table of Contents



| Abbreviation | Meaning |
|-----------------------|--|
| ABS | (Anti Blockier System) The ABS prevents wheel blocking when braking so that vehicle steerability can be maintained. |
| A.C. | Air-conditioning |
| ASR | (Antriebs Schlupf Regelung) Anti-skid regulation during acceleration. |
| Autohold | Automatic activation of the electric parking brake (EPB) when the engine is switched off. This function can be disabled |
| Auto easy exit | Automatic gearbox with limited operating. To exit the “Auto easy exit” mode, simply operate one of the two shift paddles. |
| AVH | Automatic Vehicle Hold Additional function of the electric parking brake (EPB): it allows the gradual release of brake shoes/pads when the vehicle starts up. This guarantees an optimised release for the vehicle to help the driver. |
| CST | Stability and Traction Control. Consisting of two systems: VDC and F1-Trac |
| DCT | Dual Clutch Transmission: each clutch is assigned a part of the gearbox, one designed for engaging even gears, the other for odd gears. Once a gear has been engaged, the system has already preselected the next one. Once the correct number of revs has been reached, a clutch opens whereas at the same time the other one closes so that the traction force is not interrupted. |
| EBD | (Electronic Brake-Force Distribution) Electronically-controlled brake-force distribution |
| ECU | Electronic Control Unit |
| EPB | Electric Parking Brake: the system operates by way of an ECU and an electric motor on the brake shoes of the rear brakes. |
| F1-Trac | Traction control derived from the technologies used in the racing sector. The system can estimate the maximum available grip in advance by continuously monitoring the relative wheel speed and using an auto-adaptive operation logic. Comparing this information with the vehicle dynamics model stored in the control system, F1-Trac, optimises the vehicle behaviour by controlling engine torque delivery. |

| Abbreviation | Meaning |
|-------------------------|---|
| Launch | Strategy for performance standing start. |
| Manettino | The driving mode control switch is a quick, intuitive way to make the most of vehicle potential. |
| Park Lock | Automatic DCT gearbox park lock. When the engine is off, a mechanical lock is automatically activated to prevent the vehicle from moving if the electric parking brake is not activated. |
| RHT | Retractable Hard Top |
| TFT display | Multifunction display on the instrument panel that displays information on the control system. |
| TPMS | Tyre Pressure Monitoring System. Using special sensors fixed inside the wheel rims next to the air valve, the measured data is sent to an ECU. The data and messages are displayed on the TFT display. |
| Tractability | Force exerted by the vehicle on the road surface through the wheels; it expresses grip. |
| VDC | Vehicle Dynamic Control performed through the braking system and engine torque. |
| Xenon headlights | Headlights on the front of the vehicle that produce a more intense beam by using an electric arc rather than an incandescent spiral. |

1. General
2. Quick reference guide
3. Safety
4. About your vehicle
5. Advice for Emergency Situations
6. Care of the vehicle
7. Glossary
- 8. Table of Contents**



Index

A

| | |
|--|-----|
| “Adaptive Light Control” function display..... | 130 |
| “Automatic Vehicle Holding” AVH system display | 133 |
| “Auto easy exit” gearbox..... | 159 |
| Abbreviations..... | 9 |
| ABS | 84 |
| Activation of electronic alarm | 17 |
| Active safety..... | 59 |
| Adaptive light system..... | 121 |
| Adjusting the air vents | 175 |
| Adjusting the steering wheel..... | 170 |
| Airbags..... | 72 |
| Airbag system - Components..... | 72 |
| Air conditioning and heating system..... | 172 |
| Air conditioning and heating system controls..... | 173 |
| Alarm memory..... | 19 |
| Alarm system..... | 15 |
| Ashtray..... | 176 |
| Ashtray/cigarette lighter | 176 |
| Automatic gearbox..... | 159 |

B

| | |
|--|----------|
| Backrest and cushion side width adjustment | 168 |
| Battery..... | 205 |
| Battery conditioner..... | 205 |
| Battery quick release..... | 203 |
| Before a trip..... | 153, 154 |
| Before you drive | 160 |
| Body Computer fuses and relays | 194 |
| Brake fluid..... | 225 |

C

| | |
|--|----------|
| Carwash..... | 165 |
| Chassis and bodywork maintenance | 220 |
| Child restraint systems that can be installed with 3-point seat belts - 2-seater version..... | 98 |
| Child restraint systems that can be installed with 3-point seat belts - 2 + 2-seater version..... | 98 |
| Child restraint systems that can be installed with ISOFIX - 2 + 2-seater version | 99 |
| Child safety..... | 66 |
| Child safety - 2-seater version..... | 67 |
| Child safety - 2 + 2-seater version | 69 |
| Cleaning and care of the Alcantara upholstery | 230 |
| Cleaning and care of the leather upholstery | 229, 230 |
| Cleaning the exterior..... | 228 |
| Cleaning the parking sensors..... | 137 |
| Cleaning the vehicle..... | 228 |

| | |
|---|-----|
| Clock..... | 123 |
| Closing the engine compartment lid | 103 |
| Closing the luggage compartment lid | 104 |
| Collapsible spare wheel..... | 199 |
| COMFORT mode..... | 147 |
| Consulting the manual..... | 8 |
| Consumption..... | 27 |
| Controls overview..... | 37 |
| Coolant | 223 |
| Cruise control..... | 150 |
| CST | 85 |
| CST-OFF mode..... | 147 |

D

| | |
|---|--------------|
| “Doors/Engine or luggage compartment lid open” function display..... | 131 |
| “DOWN” shift paddle..... | 148 |
| Date and hour..... | 123 |
| DCT semiautomatic gearbox oil | 223 |
| Deactivating the anti-lift alarm | 18 |
| Deactivation of electronic alarm | 18 |
| Deformable body | 59 |
| Dimensions and weights | 26 |
| Dimming of lights | 134 |
| Direction indicators..... | 47, 119, 120 |
| Disallowed roof operations | 113 |

| | |
|---|-----|
| DISP (DISPLAY) button..... | 125 |
| Dome light..... | 121 |
| Doors | 34 |
| DOWN | 158 |
| DOWN-shifting | 52 |
| Driver-side power window..... | 106 |
| Driver and passenger airbags..... | 74 |
| Driver seat Easy Entry/Exit | 170 |
| Driving | 45 |
| Driving at night..... | 161 |
| Driving in fog..... | 162 |
| Driving in the rain | 161 |
| Driving on mountain roads..... | 163 |
| Driving on snowy or icy roads | 163 |
| Driving style | 10 |
| Driving the vehicle..... | 152 |
| Driving using the driving mode control switch (“Manettino”)..... | 164 |
| Driving with the “ABS” braking system | 163 |
| Duplicating the keys..... | 16 |

E

| | |
|--|---------|
| Electrical system | 27 |
| Electronic alarm..... | 17 |
| Electronic parking brake..... | 167 |
| Electronic speedometer..... | 109 |
| Emergency opening - Engine compartment lid..... | 103 |
| Emergency opening - Fuel filler flap | 105 |
| Emergency opening of engine compartment lid | 103 |
| Emergency opening of fuel filler flap..... | 105 |
| Emergency tyre repair and inflation kit | 185 |
| Emergency unlocking of electric parking brake..... | 213 |
| Emissions..... | 27 |
| End-of-life vehicle collection service..... | 11 |
| Engine compartment lid..... | 103 |
| Engine malfunction alarm devices..... | 207 |
| Engine oil | 221 |
| Engine oil temperature gauge | 126 |
| Environmental protection..... | 10 |
| EPB | 86, 167 |
| Exhaust system overheating alarm devices..... | 206 |
| External lights and direction indicators..... | 46 |
| External lights failure display | 133 |
| External rear-view mirrors | 171 |

F

| | |
|--|---------|
| F1-Trac..... | 85 |
| Ferrari CODE system..... | 15 |
| Flaps communicating with luggage compartment | 177 |
| Flashing the headlights..... | 46, 117 |
| Fuel inertia switch..... | 83 |
| Fuel level gauge | 129 |
| Fuel tank cap and flap..... | 104 |
| Fuse..... | 190 |
| Fuses and relays in the engine compartment | 193 |
| Fuses and relays on centre console..... | 198 |

G

| | |
|-------------------------|-----|
| General remarks | 4 |
| Global Closed..... | 107 |
| Global Open..... | 107 |
| Glossary..... | 234 |
| Glove compartment | 176 |

H

| | |
|------------------------------------|----------|
| Hazard warning lights..... | 47 |
| Headlight bulbs..... | 188 |
| Headlight washer..... | 149, 151 |
| Headrest adjustment..... | 170 |
| Head Airbags..... | 78 |
| High beams..... | 46, 117 |
| Horn control..... | 148 |
| How to fasten seat belts..... | 62 |
| Hydraulic steering system oil..... | 224 |

I

| | |
|--|---------|
| Identification and homologation plates and labels..... | 20 |
| If the vehicle is stored for long periods..... | 231 |
| Ignition switch..... | 45, 165 |
| Instruments and gauges..... | 108 |
| Instrument panel warning lights..... | 139 |
| Internal electrochromic mirror..... | 171 |

K

| | |
|----------------|-----|
| Key codes..... | 14 |
| Key lock..... | 166 |
| KEY ON..... | 124 |

L

| | |
|--|-----|
| Launch..... | 166 |
| Level checks..... | 221 |
| Lighting..... | 117 |
| Light bulbs..... | 191 |
| Light switch..... | 117 |
| Locking and opening the doors from the inside..... | 102 |
| Low tyre pressure..... | 88 |
| Luggage compartment lid..... | 104 |
| Lumbar support adjustment..... | 168 |

M

| | |
|--|----------|
| Maintenance..... | 220 |
| Maintenance of seat belts and pretensioners..... | 65 |
| Maintenance of the seat belts and pretensioners..... | 228 |
| Maintenance schedule..... | 220 |
| Main engine specifications..... | 27 |
| Manettino..... | 146, 147 |
| Manual closing of retractable hard top..... | 208 |
| MENU..... | 128 |
| Menu Page..... | 123 |
| Ministerial homologation..... | 19 |
| MODE button..... | 125 |

N

| | |
|-------------------------------|-----|
| “N” (Neutral) request..... | 52 |
| Number plate light bulb | 189 |
| N - Neutral | 158 |

O

| | |
|--|-----|
| Opening doors..... | 34 |
| Opening doors from the outside..... | 102 |
| Opening the engine compartment lid..... | 103 |
| Opening the fuel tank cap flap..... | 104 |
| Opening the luggage compartment lid..... | 104 |
| Operation with the engine off..... | 49 |
| Other light bulbs..... | 189 |

P

| | |
|---|-----|
| Parking lights | 118 |
| Parking sensors | 134 |
| Park Lock..... | 165 |
| Park lock emergency release..... | 214 |
| Passenger-side power window..... | 106 |
| Passenger compartment accessories..... | 176 |
| Passenger side fuses and relays..... | 196 |
| Passive safety..... | 58 |
| Performance..... | 27 |
| Placing suitcases in the luggage compartment..... | 177 |
| Pocket-change compartment | 176 |

| | |
|---------------------------------|-----|
| Pocket-change compartments..... | 176 |
| Position II - Ignition | 166 |
| Power windows | 106 |
| Pretensioners..... | 64 |
| Push start | 159 |

R

| | |
|--|---------|
| Rain sensor failure..... | 152 |
| Rear-view mirrors | 42, 171 |
| Rear fog lights | 47, 120 |
| Rear power windows | 107 |
| Rear seat belts | 63 |
| Refilling..... | 31, 153 |
| Replacing a fuse..... | 190 |
| Replacing a wheel..... | 199 |
| Replacing other light bulbs | 189 |
| Replacing remote control batteries | 17 |
| Replacing the brake pads and brake discs | 208 |
| Replacing the headlight bulbs..... | 188 |
| Replacing the number plate light bulb..... | 189 |
| Replacing the supplementary taillight bulbs..... | 188 |
| Replacing the taillight bulbs | 188 |
| Retractable hard top | 35, 110 |
| Roll bar..... | 81 |
| Roof closing using switch..... | 112 |
| Roof in stand-by operations | 113 |
| Roof opening using switch..... | 111 |
| Roof panel controls | 146 |

| | |
|---------------------|-----|
| Running-in..... | 152 |
| Run Flat tyres..... | 30 |

S

| | |
|---|---------|
| “Speed limit” function display..... | 131 |
| Safe driving..... | 160 |
| Satellite Alarm System | 19 |
| Seats..... | 40 |
| Seat adjustment..... | 40, 167 |
| Seat back rake adjustment | 168 |
| Seat belts - Safety..... | 60 |
| Seat belts - Unfastening | 63 |
| Seat belts - use | 43 |
| Seat heating system | 170 |
| Seat position memory..... | 168 |
| Semi-automatic gearbox display (F1) | 144 |
| Service..... | 7 |
| Spare parts | 7 |
| Special Ferrari child restraint systems..... | 99 |
| Special warnings..... | 56 |
| SPORT..... | 126 |
| SPORT mode..... | 147 |
| Starting and driving the vehicle | 48 |
| Starting and driving the vehicle (DCT gearbox)..... | 154 |
| Starting the engine | 50 |
| Starting the vehicle..... | 51 |
| Start button..... | 146 |
| Stopping the vehicle | 52 |

| | |
|---|-----|
| Suitcases in the luggage compartment..... | 177 |
| Summary of TPMS displays | 95 |
| Sun radiation sensor..... | 176 |
| Sun visors | 177 |
| Supplementary taillight bulbs..... | 188 |
| Switching off the engine | 158 |

T

| | |
|---|-----|
| “TFT” display..... | 122 |
| “Tyre pressure and temperature” display..... | 132 |
| Taillight bulbs..... | 188 |
| TFT display warning light display priority levels..... | 86 |
| TFT display buttons | 122 |
| TFT display warning lights..... | 139 |
| Tilting the backrest..... | 169 |
| Toolkit..... | 184 |
| Tool bag..... | 184 |
| Towing hook..... | 202 |
| TPMS inactive | 94 |
| TPMS not calibrated..... | 92 |
| TPMS temporarily inactive | 94 |
| Transmission ratios..... | 27 |
| TRIP A/B | 127 |
| Turning off the engine and deactivating the system..... | 52 |
| Twilight sensor | 119 |
| TYRES | 127 |
| Tyres..... | 28 |
| Tyre pressure and temperature monitoring system..... | 87 |

| | |
|--|----|
| Tyre pressure monitoring system failure..... | 93 |
| Tyre puncture..... | 89 |

U

| | |
|-------------------------------------|---------|
| “UP” shift paddle..... | 148 |
| UP..... | 157 |
| UP-shifting..... | 52, 157 |
| UP-shifting due to overrevving..... | 157 |
| Updating..... | 7 |
| UP / DOWN button..... | 125 |
| Use of the vehicle..... | 10 |

V

| | |
|-------------------|----|
| VDC..... | 85 |
| Vehicle keys..... | 14 |

W

| | |
|---|--------|
| “Warning: danger of ice” display..... | 130 |
| Warming up the engine..... | 51 |
| Warning of faulty roof opening and closing..... | 116 |
| Warranty Booklet..... | 7, 220 |
| Wheels and tyres - Use..... | 226 |
| Wheel alignment check and adjustment..... | 228 |
| Wheel rims..... | 28 |
| While travelling..... | 160 |
| Windscreen and headlight washer/wipers..... | 149 |
| Windscreen washer..... | 149 |
| Windscreen wipers and washer fluid..... | 226 |
| Wind deflector..... | 180 |

Equipment and options in FERRARI vehicle models may vary because of specific legal and market requirements. The information contained in this publication is therefore not binding in any way.

FERRARI reserves the right to make any modification to the vehicle models described in this manual, at any time, for either technical or commercial reasons.

Contact the nearest FERRARI Dealer for any further information you may require.

In the interests of efficiency and safety, as well as to preserve the value of the vehicle, we do not recommend modifying the equipment using non-approved parts.

Code n° **82110300**
Catalogue n° **3384/08**

EDITION
1st edition **February 2009**

EDITING
STAR s.r.l.
Alessandria - Italia

PRINTING
STAR s.r.l.
Alessandria - Italia

COPYRIGHT® **Ferrari**

Technical Service Department
Via Abetone Inferiore, 4
41053 Maranello
Modena - Italia

