



PORSCHE



50 years of the Porsche 911

The 911 50th Anniversary Edition – Tradition: Future

S

I

I

50

Contents

The 911 50th Anniversary Edition	6
7 generations of the 911	8
Design	12
Technology	28
Personalization	38
Conclusion	46
Technical data	52





PORSCHE
WERK 1

S VM 1963

**If you like loyalty,
you will love this.**

**The 911 50th Anniversary
Edition.**

911. Three numbers. One logo. Yet they represent a legendary sports car concept. Many books have been written on the subject, but do any of them truly describe the emotion that this vehicle has been conjuring up for decades?

The 911 now has a lot of stories to tell – about heroic race wins, a design that has since become iconic, countless

childhood dreams and, above all, a timeless idea.

After 50 years it's evident that the 911 is more than just a car. But what's its secret? Attempts at the answer might include: the typically sloping roof line; the timelessness of the form; the pithy sound of its boxer engine; Swabian ingenuity; ground-breaking sports car technology;

childhood memories; that tingling feeling as you take the next bend; the defiant tenacity of engineers to do only what they believe in.

In fact, every answer is the right one. Because they are all expressions of the same idea which started life on a desk as a simple sketch. It then took form in engineering models. It was given names

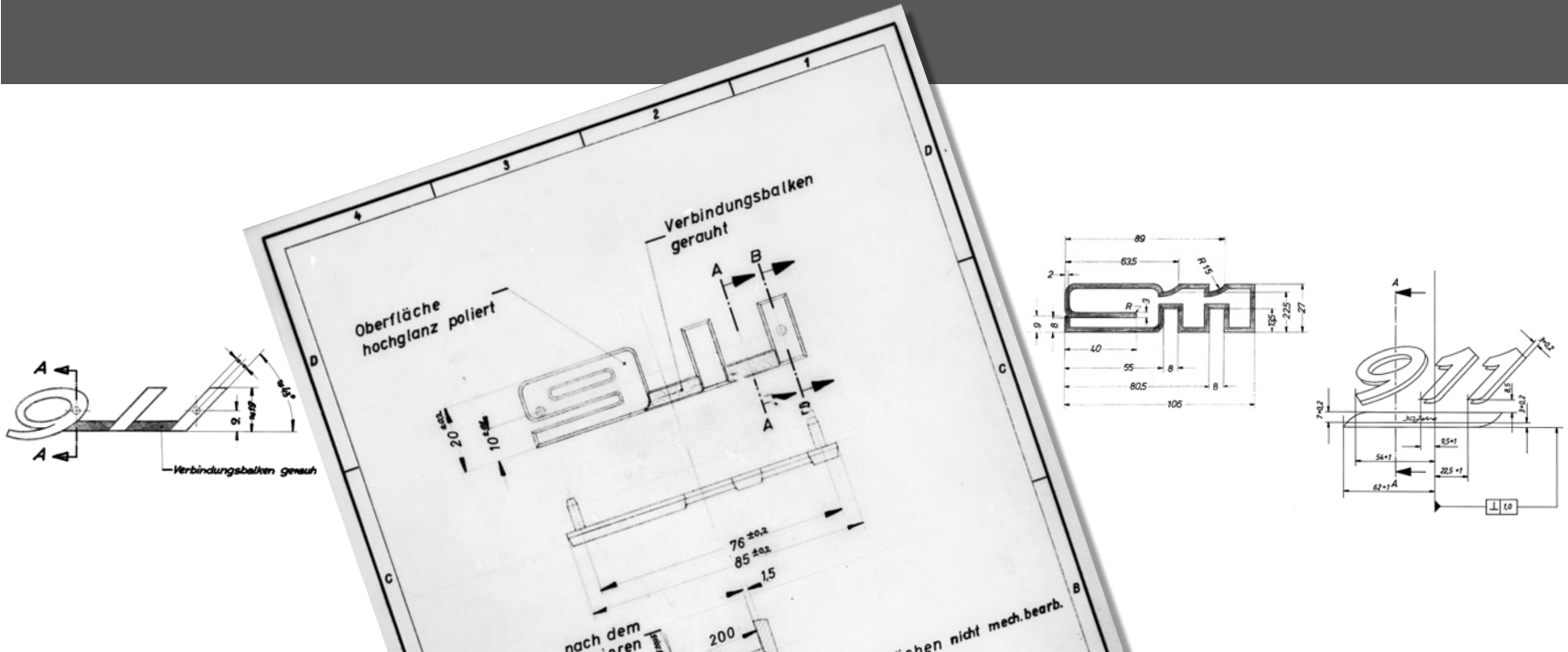

like 695, 754 T7 or T9. It was rejected. Then further developed – sometimes even at night and in the early hours of the morning. What today seems like a matter of course was a long, labor-intensive path on which every millimeter was a struggle. Success came with the design produced by Ferdinand Alexander Porsche.

The heart and soul of the Porsche brand is celebrating its 50th birthday. A good reason for us to pay tribute to the 911 model – with the 911 50th Anniversary Edition. With a limited edition of strictly 1,963 copies of the seventh generation as it will never be seen again. With high-quality equipment and finely worked details which elude to the history of the 911. With the historic '911' logo.

With a 1.7 in. wider rear. With 430 hp based on the current 911 Carrera S. Power that is worthy of the 911.

The 911. Future: Tradition. Since 1963.

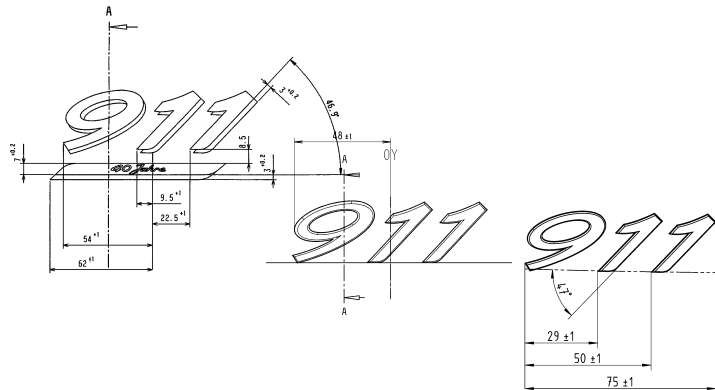

50 years ago we sent an idea into the race. The first 7 laps have been very encouraging.

7 generations of the 911.

On the podium is an idea. It was born in 1963 and has hardly aged a day since. Why? Because we don't stop at ideas. We develop them. With each new generation.

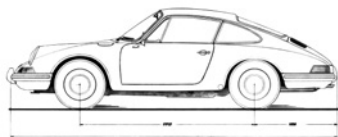

Original 911: 1963–1973

The 911 is unveiled at the Frankfurt Motor Show on September 12, 1963 when it is still known as the 901. But another car manufacturer objected to this sequence of numbers on the grounds of patent rights. Which was good for Porsche. So, Porsche simply replaced the middle 0 with a 1, and called the car Porsche 911.

As a legitimate successor to the 356, it has a 2+2 configuration (two front seats with two comfortable 'emergency seats' in the rear) and was commissioned by Ferry Porsche – but with its own shape – and with 6 cylinders at the rear. In 1964 Ferdinand Alexander Porsche puts the design of the century into series production. The power output from the 2.0-liter boxer engine starting at 130 hp – the only way is up.



911 G Series: 1973–1989

The second generation of the Porsche 911 comes onto the market in 1973. The impact bumpers are the characteristic feature of the second generation (so-called G Series) Porsche 911. The fully galvanized body, from 1975 onwards, is another forward-looking feature. As is the occupant protection: with impact-absorbing steering wheel, three-point seat belts and integrated headrests at the front. The exhaust technology is also state-of-the-art – thanks to a controlled catalytic converter (from 1985). The engine electronics brought in as of 1983 boost efficiency.

The first engines in the G Series displace 2.7 liters and develop 150 hp. In its most powerful version, with 3.2 liters of displacement, the boxer engine in the 911 Carrera reaches 231 hp.

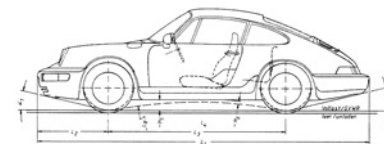

911 (1964): 1988–1994

After 25 years of 911 evolution, the third incarnation of the 911 represents a major step forward. Still featuring the signature design idiom, only 15% of the original vehicle has been retained. New features include Tiptronic, power steering and ABS – 1991 sees the addition of the first airbag as standard for driver and passenger. Also impressive is the power provided by the 3.2-liter boxer engine: 231 hp.

The most remarkable innovation relates to the number '4' in the all-wheel drive. The figure '4' after Carrera has stood for the permanent all-wheel-drive system for the 911, which proves its mettle as early as the 1984 Paris to Dakar Rally and goes into series production with the 911 Carrera 4 models. The transfer from motorsport to the road – a future-oriented Porsche tradition.

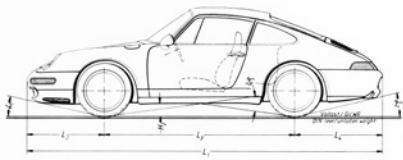
**911 (933): 1993–1998**

With its lower shape, flush headlights and seamlessly integrated bumpers, the fourth generation of the 911 appears sleeker and more streamlined than its predecessors – for improved aerodynamics and lower fuel consumption. A wider rear enhances its innate sportiness.

The 3.6-liter, 6-cylinder boxer engine delivers 272 hp to the 6-speed gearbox and reaches a top speed of 168 mph. The driving dynamics are much improved – thanks to the newly designed lightweight chassis. But one thing is on its way out: the 993 is the final Porsche 911 to have an air-cooled boxer engine.

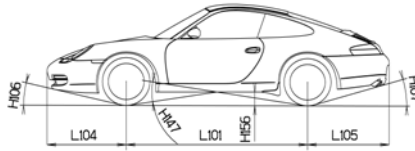
**911 (996): 1997–2005**

Featuring contemporary headlights with integral indicators, a flatter windshield and futuristic interior design, this is the first 911 with a water-cooled engine. Everyone's talking about the 996.

How sustainable it has become gets lost in all of the sparring. The fifth generation marks a major leap forward: it is lighter, has a longer wheelbase, has gained in width and provides its passengers with noticeably more space. Its engine technology and chassis set new benchmarks. Overall, the 996 is more comfortable, more efficient and more dynamic. This is due in no small part to a power output of 300 hp.

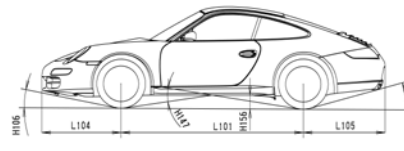
**911 (997): 2004–2012**

The 997 gets some more waist work, with the signature 911 shape becoming even more pronounced. The headlight design is round again. The wheels are bigger, the rear wider, the wings more defined. The design of the 997 reflects the roots of the 911, but the technology of the 21st century.

As of 2008, direct fuel injection (DFI) and Porsche Doppelkupplung (PDK) are used in the 911 Carrera for the first time. This increases performance – and lowers fuel consumption. On this basis, the 3.8-liter engine of the S model releases 385 hp and sprints from 0 to 60 mph in a mere 4.3 seconds.

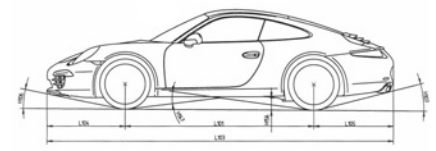
**911 (991): since 2012***

2011 sees the seventh generation of the 911 start to roll off the production line: a sports car that embraces tradition yet leaves the door to the future wide open. In the Carrera S models with 400 hp, offers trendsetting efficiency technologies like thermal management and on-board electrical system recuperation.

Thanks to an intelligent lightweight design, the new 911 is up to 66 lbs lighter than its predecessor. The wheelbase has grown by 3.9 in. In design, the rear now appears more angular and sharper. The front headlights have become more rounded. Nevertheless, the 911 is still the 911. Fully in the future tradition.











Design

A classic. From the future.

Timeless design.

They say that children keep you young. Actually, the 911 has proven its carefree, youthful behavior: it has been touching the nerve, stirring up fantasy and creating considerable enthusiasm for 7 generations.

We know, of course, that the 911 has a great power of attraction. But what is the secret of its fascination? It can't just be the fact that it has had the same name for 50 years. It must have something essential at its core.

Ferdinand Alexander Porsche hits the nail on the head: 'A formally coherent product doesn't need any embellishment'. That can be seen in every millimeter of the 911: for instance with the clear roof line, tapering dynamically down at the back – our designers call it the flyline. This typical alignment has also influenced the shape of the side windows. In memory of the original 911, the 911 50th Anniversary Edition has aluminum trim on the windows.

Characteristic of the 911 are: the roof line, side windows, the fenders which are higher than the front hood, and a muscular

look at the rear, because a Porsche has shoulders. At the front the fenders improve the overall view – Ferry Porsche called them 'Peilkanten' (guiding edges). This means that generations of 911 drivers have been able to enjoy the exterior styling from their seats. The round headlights are apparently elementary, but essential for the design. They are what make the 911 the 911.

The 911 DNA is unmistakable. And yet: our engineers and designers are always looking forward, not back. To open new doors. To build the next new 911. And make it better. To further develop lines

and proportions. With respect for tradition, but with curiosity about the future.

Because it's clear: the 911 has won the race against time, because it has never really stayed the same. Only that makes it timeless. And explains its youthfulness.

1 Ferdinand Alexander Porsche working on a type 911 model

911





**You should only quote yourself
if you have remained true to yourself.**

Design Details.

Details show the connection between yesterday and tomorrow. They are the visible expression of the evolution of the 911. And of our feelings.

A 911 does not have a classic radiator grille at the front – in any of the generations. However, it has air intakes. They characterize the face of the 911.

Anything else and the 911 would not look the same. Another design feature of the 911 is its rear. To be more precise: the rear lid grille. Giving a clear indication of where the engine is in a 911: at the back.

Typical 911 elements have been taken up by the 911 50th Anniversary Edition. With finely honed details – and as a homage to its predecessors: the air intake slats and



the black-painted rear lid grille are accentuated with chrome. Its faithfulness to the first generation can also be seen in the chrome strips between the rear lights and the high-gloss trim strips around the side windows. High-quality features form a stylistic connection – with the first 911 sports car from 1963.

The SportDesign side mirrors and the distinctive front spoiler lip are details from the present – directed towards the future of the 911.

The styling of the wide rear is another such characteristic of the 911. And with the 911 50th Anniversary Edition we have emphasized it even further. The body is

1.7 in. wider at the back over the current rear-wheel drive 911 Carrera models. Thanks to the wider profile, the 911 50th Anniversary Edition sits even more solidly on the road and the trim strips between the rear lights emphasize the horizontal styling of the rear. Low, wide, sleek – a full-blooded sports car with rear-wheel drive.

A small but distinctive design detail of the 911 50th Anniversary Edition is possibly the most emotive: the '911 50' logo on the back. It evokes the famous typography of the earlier 911 models. Seldom, it seems, have tradition and future been closer together.



**Once the past catches up with us,
we have arrived in the middle of the future.**

The Fuchs wheel, reinterpreted.

A classic aluminum wheel with five spokes – and not a single spoke more. The Fuchs wheel has become a legend in its own right. And arouses a lot of memories. Because if, as a child, you craned your neck to look at a 911, often enough you would see it driving through the streets on Fuchs wheels.

Actually, the history of the Fuchs wheel is closely associated with Porsche. In the mid-60s our engineers were looking for a lightweight wheel that would still be extremely resilient. They knew that the steel or cast-iron wheels that were common at that time – unlike today – would not meet those contradictory requirements.



Otto Fuchs KG in Meinerzhagen offered the solution: cast light-alloy wheels that were made from aluminum to provide less weight – always a central theme with sports cars – and thereby reduce unsprung masses; with corresponding benefits in driving comfort and agility. The Porsche designer, Heinrich Klie, was responsible for the design. Another great success from the Porsche design team.

The Fuchs wheel first appeared on the road in 1966, on the Porsche 911 S, and was available as a standard feature until 1989. It has lost nothing of its timeless beauty.

For the developers of the 911 50th Anniversary Edition, it went without saying that this icon should be included in a model embodying both tradition and future. In a

classic design, with a technologically state-of-the-art interpretation, five spokes, aluminum, 20-inch. The Sport Classic wheel in the Fuchs rim design is painted in black (semi-gloss), the center spokes and rim are polished – giving the children of our time still good reason to crane their necks.







Something you can still read off the rev counter: sports car history.

Interior.

If you take a look inside the first 911, you can see how much time has passed. In direct comparison, the 911 50th Anniversary Edition looks like a precision instrument: with the rising center console, the SportDesign steering wheel and Porsche Communication Management (PCM) for audio, navigation and communication.

And yet, there is one thing that hasn't changed since 1963: the driver orientation. From the outset it has been about concentrating on what is important.

The very first 911 had five round instruments, with the rev counter positioned in the middle. In those days, the ignition key was where it is today, to the left of the steering wheel – as a tribute to the Le Mans start in which the drivers had to sprint to the car and could start the engine more quickly with the ignition on the left.

Above all, there was one detail that lay close to the heart of our car developers in the 911 50th Anniversary Edition: the instruments. Until 1967, the figures and

scale on the black instruments were green and the pointers were white. For good legibility and utmost functionality. In the 911 50th Anniversary Edition – in the same colors as then – they have become a subtle and yet noticeable design reference that is also reflected in the Sport Chrono clock as part of the standard Sport Chrono Package. The '911 50' logo in the black rev counter illustrates the identity of the 911 50th Anniversary Edition.

The optional Burmester® High-End Surround Sound System ensures the

perfect tone, as is only fitting for the timeless sound of a 911 – thanks to 12 individually controlled loudspeakers and a total output of 821 watts.

A design feature that is noticeable as soon as you get in: the two-tone '911 50' logo on the door-sill guards. The trim strips on the doors and dashboard are in brushed aluminum. Above the glove compartment, a plate next to the anniversary model logo shows your personal limited edition number – which also makes you part of the 911 history.













Technology







What's the quickest way to connect tradition and future?

4.2 seconds.

Drive.

Low in the back and sitting just above ground – when it comes to the position of the engine, we are extremely conservative. The drive is – and will always be – at the back. The construction principle is also classic: 6 cylinders, in a boxer arrangement, with that full Porsche sound. Typical 911 attributes.

So that's the tradition part. Let's get to the future. Because the 3.8-liter displacement catapults the seventh generation 911 into a new era. And makes it a key sporting player. The engine of the 911 50th year Carrera S power kit as

standard, develops 430 hp at 7500 rpm. And its maximum torque of 325 lb.-ft. is achieved at 5,750 rpm. A sport exhaust with polished tail pipes is standard in the anniversary model. Giving it a more intensive sports car sound at the press of a button.

Based on the 911 Carrera S engine, the 911 50th Anniversary Edition, with 7-speed manual gearbox, accelerates from 0 to 60 mph in just 4.2 seconds, and boasts a top track speed of 188 mph.

Available as an option is the especially efficient 7-speed Porsche Doppelkupplung

(PDK). For gear changes in milliseconds – without interrupting the flow of power. It also reduces fuel consumption significantly and offers a more comfortable drive. And with even higher acceleration values compared to the manual gearbox: with PDK, the anniversary model sprints to 60 mph in only 3.8 seconds and reaches a top track speed of 187 mph, with the standard Sport Chrono Package and Sport Plus.

But further developing the 911 doesn't always mean making it faster, but always to make it more efficient. This requirement is also expressed in the seventh

generation 911 – now more than ever. Efficient technologies, as standard, are therefore an integral part of the car concept in the 911 50th Anniversary Edition as well: e.g. with the Auto Start Stop function, intelligent thermal management or the electrical system recuperation.

Drive. It's the heart of what we call Tradition: Future.



50 years of the 911 haven't always gone in a straight line. Which is great!

Chassis.

Let's start at the back: in the rear. More precisely, with the wide track. The 911 50th Anniversary Edition is 1.7 in. wider at the back than the 911 Carrera S and boasts greater road holding. And greater stability. In every corner.

Let's consider road holding. Our engineers have extended the wheelbase of the latest 911 generation by 3.9 in. So the car sits more solidly on the road and driving stability is increased, especially at high speeds and when cornering fast.



A crucial contribution to the typical Porsche driving feel is made by the standard suspension management systems, such as Porsche Stability Management (PSM) and Porsche Active Suspension Management (PASM), with the body lowered by 10 mm. Also standard: Porsche Torque Vectoring (PTV).

The system works, among others, by specifically braking the rear wheels as the situation demands. For even more dynamic steering.

Sportiness is further increased: with the standard SPORT button or the SPORT PLUS button in conjunction with the

standard Sport Chrono Package with dynamic engine. They make the chassis, engine and gearbox settings even sportier. In keeping with the 911 50th Anniversary Edition: the Sport Chrono clock has a black dial, green scale markings and white pointers.

One thing has not changed in 50 years of the 911: the fun of cornering.





**Since 1963 we have been interested in the future.
Especially the extremely near future.**

Balance.

Knowing what's coming. Being prepared. For the next bend. For the next maneuver. From motorsport we know that if you have a lot of power you need control. On this basis we haven't changed much in 50 years of the 911. But we have improved significantly.

The 911 50th Anniversary Edition has more power than the 911 Carrera S model

and a corresponding safety buffer with the brakes: With red painted six-piston aluminum monobloc fixed calipers at the front and four-piston aluminum monobloc fixed calipers at the rear. For greater braking performance and stability.

In addition to two-stage driver and passenger airbags, the 911 50th Anniversary Edition is equipped with the Porsche Side Impact Protection System (POSIP).

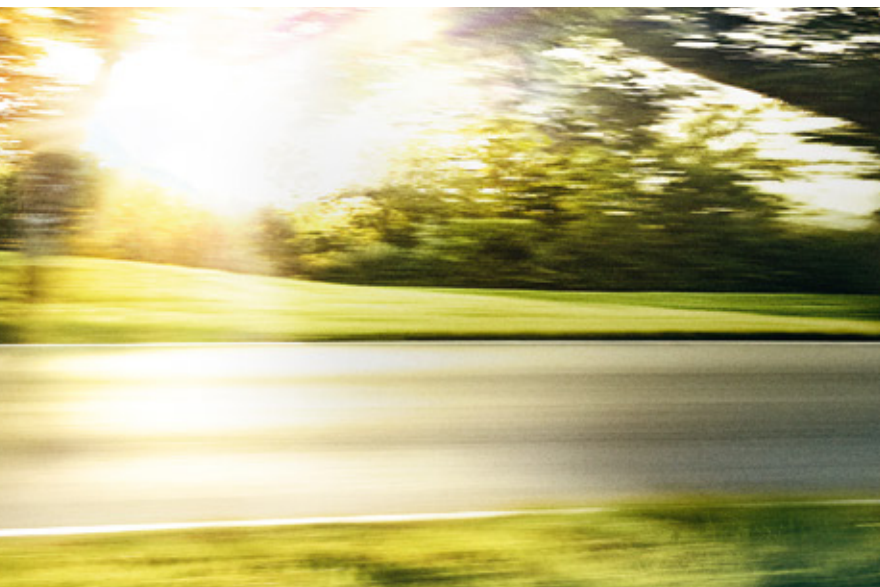

Bi-Xenon™ headlights with headlight cleaning system and dynamic range control are fitted as standard. The front lights incorporate LED direction indicators, daytime running lights and position lights. The Porsche Dynamic Light System (PDLS) is also fitted as standard. Its dynamic cornering light function swivels the headlights towards the inside of a bend, based on steering angle and road speed.

Also available as an option are the new LED headlights, including Porsche Dynamic Light System Plus (PDLS Plus). And its innovative design is apparent not just at night. The daytime running lights in the LED headlight consists of four LED spotlights and a ring of LEDs. The main beam and auxiliary high beam are also based on LED technology, as are the side indicators and marker lights. For better illumination – and less energy consumption.

One special feature of PDLS Plus: the dynamic headlight adjustment. A camera identifies the light from vehicles in front and oncoming vehicles and turns off and on the high beam accordingly, continuously and smoothly.

If you are looking back on 50 years of sports car history, you also want to know what's going to happen in the really near future.







Personalization





No two 911 dreams are the same.

Color.

1



2

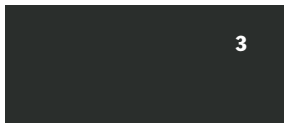

3

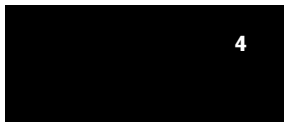

4



5

1 Metallic exterior color:
Geyser Grey Metallic

2 Classic interior: Agate Grey/Geysers Grey

3 Non-Metallic exterior color:
Graphite Grey

4 Non-Metallic exterior color:
Black

5 Classic interior: Black/Dark Silver



**It is in our nature to
strive for perfection.**

Seats.

The first principle of every 911 since 1963: sportiness. But always with a high degree of comfort and using high-quality materials. That has never been a contradiction, but rather a wise combination of assumed contrasts.

The main materials inside the 911 50th Anniversary Edition are leather and aluminum. The classic interior is available in Agate Grey/Geyser Grey or Black/Dark Silver. With a special feature: the seat

center of the front and rear seats, taking up an iconic material and pattern from the first 911 models: the so-called Pepita – a two-tone woven textile with a small diamond pattern. The impression it gives is classic and, in the context of the modern interior, it is timeless. The sides of the seats have seams in a contrasting color – Geyser Grey or Dark Silver. The seams are also on the top of the dashboard, the door, SportDesign steering wheel and floor mats.

Power Sport Seats with 14-way adjustment are fitted as standard. Available as an option are the Adaptive Sports Seats Plus, which adjust optimally to your requirements thanks to the 18-way electric adjustment. Optional seat heating is available for both types of seat.

One small, fine detail that you notice as you get in, but not while you are driving: the stitched three-tone '911 50' logo on the headrests.





Bi-Xenon™ headlight incl. PDLS (standard equipment)



LED headlight incl. PDLS Plus



Power folding side mirror incl. courtesy lighting

Product

Exterior.

	911 50th Anniversary Edition	I no.
LED headlights incl. Porsche Dynamic Light System Plus (PDLS Plus)	•	602
Bi-Xenon™ headlights in black, incl. Porsche Dynamic Light System (PDLS)	•	XEX
Porsche Entry & Drive	•	625
ParkAssist (rear)	•	635
ParkAssist (front and rear)	•	636
Rear windshield wiper	•	425
Power folding side mirrors including courtesy lighting Note: with this option, the standard 911 Carrera mirrors are fitted instead of the SportDesign mirrors	■	748
Electric sunroof	•	651
Sunroof in glass	•	653
Roof transport system	•	549
Headlight cleaning system cover painted in exterior color	•	XUB
Fuel filler cap with aluminum look finish	•	XYB

Product	911 50th Anniversary Edition	I no.
Engine, transmission and chassis.		
7-speed Porsche Doppelkupplung (PDK)	•	250
Porsche Ceramic Composite Brake (PCCB)	•	450
PASM sport suspension (20 mm lower)	•	030/031
Porsche Dynamic Chassis Control (PDCC)	•	031/352
Power Steering Plus	•	658
Interior.		
Adaptive Cruise Control incl. Porsche Active Safe (PAS)	•	456
Light Design Package	•	630



Porsche Ceramic Composite Brake (PCCB)



Carrera S Powerkit

Product	911 50th Anniversary Edition	I no.
Interior.		
Automatically dimming mirrors	•	276
Adaptive Sport Seats Plus (18-way) with memory package incl. electric steering column adjustment	•	P07
Seat heating	•	342
Seat ventilation (only in conjunction with seat heating and Adaptive Sport Seats Plus) Note: with this option, the seat center is in leather instead of fabric.	•	541
Steering wheel heating (only in conjunction with multifunction steering wheel)	•	345
Fire extinguisher	•	509
Smoking package	■	583
Luggage net in passenger foot-well	■	581
Vehicle key painted	•	CPK
Rear foot-well lighting	•	CEE

¹⁾ May be incompatible with some copy-protected CDs.

²⁾ Only in conjunction with PCM.

³⁾ Mobile phone preparation or telephone module in HFP mode: the use of a mobile phone inside a car may cause an increase in the interior electromagnetic field strength and, accordingly, in the electromagnetic radiation to which passengers are exposed. If a cradle is used to mount the mobile phone, the field strength in the passenger compartment can be reduced because your phone can be connected up to the external aerial (feature depends on how specific mobile phones connect to the cradle). For information about the availability of a cradle for your mobile phone, please contact an independent accessories retailer. The use of the telephone module for PCM via Bluetooth® SAP connection or with inserted SIM card prevents exposure to electromagnetic radiation as only the car's external aerial is ever used.

⁴⁾ Information on compatible mobile phones is available at www.porsche.com or your Porsche Dealer.

⁵⁾ For receiving analogue and digital television signals (DVB-T) in MPEG2 encoding where available.

Product	911 50th Anniversary Edition	I no.
Interior: leather.		
Multifunction steering wheel Note: with this option there is no deviated stitching	•	844
Additional Interior Package, dashboard in leather	•	CZW
Additional Interior Package, door panel in leather	•	CXM
Additional Interior Package, in leather in rear	•	CXN
Instrument surround in leather	•	XNG
Steering column casing in leather	•	XNS
Rear-view mirror in leather	•	CVW
Air vents in leather	•	CTK
Air vent slats in leather	•	CZV
PCM package in leather	•	CUR
Sport Seat Plus backrest shell in leather	•	XWK
Seat belt outlet trim in leather	•	CTH
Fuse box cover in leather	•	CUJ
Leather key pouch	•	CPE
Interior Alcantara®.		
Seat belt outlet trim in Alcantara®	•	CLN
Interior Aluminum.		
Pedals and footrest in Aluminum	•	EFA

Product	911 50th Anniversary Edition	I no.
Audio and communication.		
SiriusXM® Satellite Radio receivers	•	686
HD Radio receiver	•	688
SiriusXM® Satellite Radio and HD Radio receivers	•	690
Electronic logbook ²⁾	•	641
Voice control ²⁾	•	671
Telephone module ^{3),4)}	•	666
Cordless handset for telephone module ^{2),3)}	•	669
BOSE® Surround Sound System	•	680
Burmester® High-End Surround Sound System	•	682
6-DISC CD/DVD changer ¹⁾	•	693
Online Services ²⁾	•	UN1
Factory collection		
European delivery (Zuffenhausen)	•	900
European delivery (Leipzig)	•	S9Y



Adaptive Sport Seat Plus in conjunction with seat ventilation



Multifunction steering wheel



Vehicle key painted, leather key pouch





**There are more than a million words in the English language.
But only three numbers can describe this feeling.**

911.

The 911 has a quantity that can't really be measured. But it's one we have been working on every day since 1963: feelings. Because if the 911 was just any other car, it would not fascinate its driver. It's like the first time. Every time.

Yes, the 911 is our acknowledgement to the sports car. It stands for everything we believe in. And for what we are striving towards.

If necessary, we will scrutinize every single screw to achieve it. It's the only way of staying open to new ideas and intelligent drive concepts. It's the only way of living up to the Dr. Ing. in our company name. And of being able to give the 911 a future.

The 911.

911









911

Technical data.

911 50th Anniversary Edition

Engine	
Cylinders	6
Displacement	3.8 liter
Max. power (DIN) at rpm	430 hp 7,500 rpm
Max. torque at rpm	325 lb.-ft. 5,750 rpm
Compression ratio	12.5:1
Transmission	
Layout	Rear-wheel drive
Manual gearbox	7-speed
PDK (optional)	7-speed
Chassis	
Front axle	McPherson strut suspension with anti-roll bar
Rear axle	Multi-link suspension with anti-roll bar
Steering	Electromechanical power steering with variable steering ratio
Turning radius	36.4 feet
Brakes	Six-piston aluminum monobloc fixed calipers front, four-piston aluminum monobloc fixed callipers rear, discs internally vented and cross-drilled (340 mm-F, 330 mm-R)
Vehicle stability system	Porsche Stability Management (PSM) including ABS with additional brake functions
Wheels	Front: 9.0 J x 20 Sport Classic Wheels with Fuchs design rims, Rear: 11.5 J x 20 Sport Classic Wheels with Fuchs design rims
Tires	Front: 245/35 ZR 20, Rear: 305/30 ZR 20

¹⁾ Weight is calculated in accordance with the relevant EC Directives and is valid for vehicles with standard specification only. Optional equipment increases this figure. The figure given includes 68 kg for the driver and 7 kg for luggage.

²⁾ Data determined in the NEDC (New European Driving Cycle) in accordance with the Euro 5 (715/2007/EC and 692/2008/EC) measurement method. The figures do not refer to an individual vehicle nor do they constitute part of the offer. They are intended solely as a means of comparing different types of vehicle. You can obtain further information about individual vehicles from your Porsche Center. Fuel consumption calculated for vehicles with standard specification only. A vehicle's fuel consumption and CO₂ emissions depend not only on its efficient use of fuel but also on driving style and other non-technical factors. Actual consumption and performance may vary with items of optional equipment.

911 50th Anniversary Edition

Weights	Manual/PDK
Curb Weight	3,109 lbs./ 3,153 lbs.
Performance	Manual/PDK
Top track speed	188 mph/ 187 mph
0–60 mph	4.2 s/ 3.8 secs
Quarter mile	12.5 s/ 12.1 secs
Fuel consumption/emissions²⁾	Manual/PDK
City	TBD
Highway	TBD
Combined	TBD
Dimensions/aerodynamics	
Length	177.52 in.
Width (with mirrors folded)	72.91 in.
Height	50.98 in.
Front track	60.55 in.
Rear track	61.42 in.
Wheelbase	96.46 in.
Luggage compartment volume (with seats folded)	9.18 cu.-ft.
Tank capacity	16.9 gal.
Drag coefficient	.30
Trunk Capacity	5.12 cu.-ft.

911 Carrera models	911 Carrera	911 Carrera S	911 Carrera 4	911 Carrera 4S
Fuel consumption/emissions¹⁾	Manual/PDK	Manual/PDK	Manual/PDK	Manual/PDK
City	19/20	19/19	19/20	18/19
Highway	27/28	27/27	27/28	26/26
Combination	22/23	22/22	22/23	21/22

911 Carrera models	911 Carrera Cabriolet	911 Carrera S Cabriolet	911 Carrera 4 Cabriolet	911 Carrera 4S Cabriolet
Fuel consumption/emissions¹⁾	Manual/PDK	Manual/PDK	Manual/PDK	Manual/PDK
City	19/20	19/19	19/20	18/19
Highway	27/28	27/27	26/27	26/26
Combination	22/23	22/22	21/22	21/21

¹⁾ Data determined in the NEDC (New European Driving Cycle) in accordance with the Euro 5 (715/2007/EC and 692/2008/EC) measurement method. The figures do not refer to an individual vehicle nor do they constitute part of the offer. They are intended solely as a means of comparing different types of vehicle. You can obtain further information about individual vehicles from your Porsche Centre. Fuel consumption calculated for vehicles with standard specification only. A vehicle's fuel consumption and CO₂ emissions depend not only on its efficient use of fuel but also on driving style and other non-technical factors. Actual consumption and performance may vary with items of optional equipment.

Dr. Ing. h.c. F. Porsche AG is the owner of numerous trademarks, both registered and unregistered, including without limitation the Porsche Crest®, Porsche®, Boxster®, Carrera®, Cayenne®, Cayman®, Panamera®, Speedster®, Spyder®, Tiptronic®, VarioCam®, PCM®, PDK®, 911®, 4S®, 918 Spyder™, FOUR, UNCOMPROMISED®, and other model names and numbers, and the distinctive shapes of the Porsche automobiles, such as the federally registered 911 and Boxster automobiles. The third-party trademarks contained herein are the properties of their respective owners. Porsche Cars North America, Inc., believes the specifications to be correct at the time of printing. Specifications, performance standards, standard equipment, options, and other elements shown are subject to change without notice. Some options may be unavailable when a car is built. Some vehicles may be shown with non-U.S. equipment. Please ask your dealer for advice concerning the current availability of options and verify the optional equipment that you ordered. Porsche recommends seat-belt usage and observance of traffic laws at all times.

© 2013 Porsche Cars North America, Inc.
980 Hammond Drive
Suite 1000
Atlanta, GA 30328
www.porscheusa.com

Edition: 04/2013
Printed in Germany
WSLS1401000223 EN/US



